

Disclaimer: The contents of this guidance document does not have the force and effect of law and is not meant to bind the public in any way. This document is intended only to provide clarity to the public regarding existing requirements under the law or agency policies.

**UNITED STATES DEPARTMENT OF AGRICULTURE
Rural Development Utilities Programs**

BULLETIN 1724E-302

RD-GD-2008-55

SUBJECT: Design Guide for Oil Spill Prevention and Control at Substations

TO: All Electric Borrowers

EFFECTIVE DATE: Date of Approval

OFFICE OF PRIMARY INTEREST: Transmission Branch, Electric Staff Division

FILING INSTRUCTIONS: This bulletin replaces Bulletin 1724E-302, Design Guide for Oil Spill Prevention and Control at Substations, issued in April 1993.

AVAILABILITY: This bulletin can be accessed via Internet at:

<http://www.usda.gov/rus/electric/bulletins.htm>

PURPOSE: This bulletin provides guidance and assistance in protecting the environment against accidental oil spills. This publication aids the electric borrower in interpreting Federal regulations and developing the necessary documents and oil retention systems to meet these regulations.



Assistant Administrator
Electric Program

January 14, 2008

Date

BLANK PAGE

TABLE OF CONTENTS

CHAPTER 1: INTRODUCTION

- 1.1 SCOPE OF BULLETIN..... 9
- 1.2 PURPOSE OF BULLETIN 9
- 1.3 EPA REGULATIONS 9
- 1.4 SCOPE OF AN SPCC PLAN 10
- 1.5 NEED FOR AN EFFECTIVE SPCC PLAN 10

CHAPTER 2: GENERAL INFORMATION CONCERNING SPCC PLANS

- 2.1 FACILITIES AFFECTED BY EPA REGULATIONS 11
- 2.2 PERSONS RESPONSIBLE FOR SPCC PLANS..... 13
- 2.3 NAVIGABLE WATERS..... 13
- 2.4 COMPLETION OF SPCC PLAN..... 14
- 2.5 CERTIFICATION OF SPCC PLAN 14
- 2.6 SAFEKEEPING OF SPCC PLAN 14
- 2.7 AMENDMENTS TO THE SPCC PLAN 14

CHAPTER 3: ELECTRICAL FACILITY APPLICABILITY

- 3.1 REGULATIONS..... 17
- 3.2 FACTORS INFLUENCING THE EXTENT OF DAMAGE OF AN OIL SPILL..... 17
- 3.3 OIL CAPACITIES OF EQUIPMENT..... 18

CHAPTER 4: GUIDELINES FOR PREPARATION AND IMPLEMENTATION OF AN SPCC PLAN

- 4.1 GENERAL 21
- 4.2 MAJOR SECTIONS OF AN SPCC PLAN 21
- 4.3 CONTENTS OF AN SPCC PLAN..... 21
- 4.4 SUBSTITUTION OF AN SPCC SPILL CONTINGENCY PLAN FOR REQUIRED PREVENTION MEASURES..... 22
- 4.5 USING SOFTWARE TO MODEL SPILLS.....23

CHAPTER 5: CHEMICAL AND PHYSICAL PROPERTIES OF OIL

- 5.1 PROPERTIES OF OIL 25
- 5.2 CHEMICAL CHANGES MADE BY OIL..... 25
- 5.3 BIOLOGICAL CHANGES TO OIL 25
- 5.4 NATURAL AND ENVIRONMENTAL CONDITIONS INFLUENCING THE DAMAGE5FROM OIL SPILLS..... 25
- 5.5 THE BEHAVIOR OF OIL WHEN USING BOOMS 30

CHAPTER 6: OIL SPILL PREVENTION TECHNIQUES

- 6.1 OIL RETENTION SYSTEMS..... 33
- 6.2 YARD SURFACING AND UNDERLYING SOIL 33
- 6.3 PIT LINERS AND SEALERS..... 34
- 6.4 SUBSTATION DITCHING 35
- 6.5 COLLECTING POND WITH TRAP 36

6.6 POLYMER AGENTS.....	39
6.7 OIL SEPARATOR TANK	43
6.8 OIL STOP VALVE.....	44
6.9 GRAVEL-FILLED EQUIPMENT PITS.....	45
6.10 OIL CONTAINMENT PITS	50
6.11 SUMP PUMPS.....	52
6.12 GATE VALVES	54
CHAPTER 7: OIL CONTAINMENT IN NAVIGABLE WATERS	
7.1 GENERAL.....	55
7.2 BOOMS	55
7.3 CONTAINMENT DAMS.....	69
7.4 COLLECTING AGENTS.....	72
CHAPTER 8: OIL REMOVAL MATERIALS	
8.1 SORBENTS	73
8.2 MINERAL PRODUCTS	73
8.3 WHEN AND HOW TO USE SORBENTS	76
8.4 BIOLOGICAL DEGRADATION	81
8.5 COMBUSTION	82
8.6 SINKING AGENTS	83
CHAPTER 9: OIL REMOVAL ON WATER	
9.1 OIL REMOVAL METHODS.....	85
9.2 VACUUM UNITS	85
9.3 SKIMMERS.....	86
CHAPTER 10: OIL SPILLS ON LAND	
10.1 MIGRATION OF PETROLEUM PRODUCTS IN SOIL AND GROUNDWATER.....	91
10.2 ROCKS AND SOIL.....	91
10.3 GROUNDWATER	92
10.4 BEHAVIOR OF SPILLED OIL IN SOIL	94
10.5 LAND SPILL CONTROL AND RECOVERY	98
10.6 GROUNDWATER REMOVAL	99
10.7 GROUNDWATER ABSORPTION	108
10.8 SOIL WASHING.....	108
CHAPTER 11: OIL DISPOSAL	
11.1 RECLAMATION	109
11.2 BURNING	109
11.3 INCINERATION.....	110
11.4 GENERATING STATION DISPOSAL.	110
11.5 BURIAL.....	110
11.6 LAND SPREADING (LAND FARMING).....	111

TABLE OF FIGURES

Figure 5-1: Some Properties of Petroleum Products That Affect Spill Behavior.....	26
Figure 5-2: A Hypothetical Floating Barrel of Oil	27
Figure 5-3: Oil Spreading... ..	28
Figure 5-4: Development of an Oil Slick.....	29
Figure 5-5: Typical Spill Distribution Patterns.....	29
Figure 5-6: Entrainment Failure.....	31
Figure 6-1: Methods of Ditch Construction.....	35
Figure 6-2: Typical Oil Drainage System for 345/138 kV Outdoor Substation... ..	36
Figure 6-3: Cross Section of Oil Drainage System.....	37
Figure 6-4: Oil Trap or Skimming Unit... ..	37
Figure 6-5: Oil Trap in Containment Pit.....	38
Figure 6-6: Oil Trap Construction Using Galvanized or PVC Pipe.....	39
Figure 6-7: Imbiber Beads® Gravity-Flow Drain Protection System-Operational Process... ..	40
Figure 6-8: Example of an Imbiber Beads® Gravity Drain Protection System	41
Figure 6-9: Imbiber Beads® Gravity-Flow Drain Protection System–Curb Application	41
Figure 6-10: Typical Construction of Oil Separator Tank.....	43
Figure 6-11: Transformer–Accumulating Tank Combination.....	44
Figure 6-12: Oil Stop Valve Installation.....	45
Figure 6-13: Plan View of Equipment Pit.....	47
Figure 6-14: Details of Equipment Pit.....	48
Figure 6-15: Typical Drain Pit.....	49
Figure 6-16: Oil Containment Pit	50
Figure 6-17: Transformer Dike.....	51
Figure 6-18: Dike, Sponge Area, and Stile Details.....	52
Figure 6-19: Above Grade Sump Pump Discharge.....	53
Figure 6-20: Schematic Diagram of Sump Pump Control Using Equipment Oil Limit Switch or Oil Sensing Probe	53
Figure 6-21: Motor-Operated Gate Valve.....	54
Figure 7-1: Components of a Boom.....	56
Figure 7-2: Boom Tension Members.....	58
Figure 7-3: Boom Couplings.....	59
Figure 7-4: Boom “Planing” in Current.....	60
Figure 7-5: Wind Effect on Oil Movement.....	62
Figure 7-6: Action of Spilled Oil in Fast Current Rivers.....	63
Figure 7-7: Flexible vs Rigid Skirts	64
Figure 7-8: Anchoring a Boom in Deep Water	65
Figure 7-9: Suggested Boom-to-Shoreline Angles for Different Current Velocities	66
Figure 7-10: Possible Problems Caused by Improper Boom Anchoring.....	67
Figure 7-11: Moving Deployment	68
Figure 7-12: Changing Currents	69
Figure 7-13: Earthen Dam, Cross Section	70
Figure 7-14: Earthen Dam, Cross Section	70
Figure 7-15: Cross Section of a Sorbent Fence	71

Figure 8-1: Straw Skimmer..... 79

Figure 8-2: Straw Skimming Installation..... 79

Figure 9-1: Tank Truck..... 86

Figure 9-2: Three Types of Enlarged Suction Heads (A) Duckbill, (B) Pipe Extension, (C) Flexible 87

Figure 9-3: Weir Skimmer Operation 88

Figure 10-1: Hypothetical Groundwater System 93

Figure 10-2: Generalized Shapes of Spreading Cones at Immobile Saturation..... 95

Figure 10-3: Demonstration of Possible Migration to Outcrop, Followed by Second Cycle of Groundwater Contamination..... 96

Figure 10-4: Movement to Groundwater 97

Figure 10-5: Contaminating Effect on Soil Caused by Vertical Movement of Oil on Fluctuating Water Table..... 98

Figure 10-6: Fluid Oil Floating on Water Table and Showing Elongation of “Pancake” in Direction of Water Movement 100

Figure 10-7: Oil on Water Table is Trapped in Cone of Depression Created by Drawdown of Pumping Well 100

Figure 10-8: Oil Moving with Shallow Groundwater Intercepted by Ditch Constructed Across Migration Path 101

Figure 10-9: System for Skimming Water Surface in Ditches or Wells..... 102

Figure 10-10: Typical Conditions During Latter Stage of Migration of Oil to Water Table..... 103

Figure 10-11: Effect on Water Table of Pumping from Well C 104

Figure 10-12: Diagrammatic Illustration of Development of a Cone of Depression Based on an Actual Aquifer Test 105

Figure 10-13: Selected Drawdown Data for an Aquifer Test 105

Figure 10-14: Drawdown Configuration of Well Pumping from Inclined Water 106

Figure 10-15: Well Pumping Using Two Pumps..... 107

TABLE OF APPENDICES

Appendix A—EPA Regional Offices
Appendix B—Normal Precipitation Tables
Appendix C—SPCC Typical Example
Appendix D—Optional SPCC Wall Plan
Appendix E—Contributors

ABBREVIATIONS

Agency — Refers to “Rural Development Utilities Programs”
CFR—Code of Federal Regulations
EPA—Environmental Protection Agency FOA—
Forced oil and air (Transformer) IEEE—Institute of
Electrical and Electronic Engineers OA—Oil and air
(Transformer)
OCB—Oil circuit breaker
PE—Professional engineer
PVC—Polyvinylchloride
RD—Rural Development Utilities Programs
SPCC—Spill Prevention Control and Countermeasure Plan
ppm—Parts per million
CI—Also known as “Cheap Insurance”
HDPE—High density polyethylene
HFB—Hydrocarbon flow barriers
NAPL—Nonaqueous phase liquid EPRI—
Electrical Power Research Institute
MOSES-MP—Mineral Oil Spill Evaluation System- Multi-Phase
MP—Multi-Phase
PCB—Polychlorinated biphenyl

BLANK PAGE

CHAPTER 1 INTRODUCTION

1.1 SCOPE OF BULLETIN

This bulletin covers oil spill prevention and control as a result of accidental discharges of oil from power facilities and electrical equipment containing oil. Topics include (1) applicability of Oil Pollution Prevention Regulations (40 CFR, Part 112) published by the Environmental Protection Agency (EPA) regarding electrical facilities and equipment; (2) preparation and implementation of an oil spill prevention, control, and countermeasure (SPCC) plan for those facilities that, because of their proximity to navigable waters and amount of oil contained, are required by EPA regulations to have an operational SPCC plan; (3) properties of oil commonly used or stored in electrical facilities and equipment; (4) techniques, procedures, and methods for oil spill prevention, its containment, removal, and disposal; and (5) an example of a typical SPCC plan.

1.2 PURPOSE OF BULLETIN

This bulletin is intended only as a guide to enable electric program borrowers to meet the requirements of the EPA regulations. Each borrower, however, is responsible for assuring compliance with the regulations.

1.3 EPA REGULATIONS

The original Spill Prevention, Control, and Countermeasure (SPCC) rules were published on Dec. 11, 1973 (38 Fed. Reg. 34164). Revisions to the SPCC program were initially proposed on Oct. 22, 1991 (56 Fed. Reg. 54612). Subsequent proposals to amend the SPCC regulations were made in 1993, 1997, and 1999. Final SPCC Phase I amendments were published on July 17, 2002 (67 Fed. Reg. 47042). The final Phase I amendments became effective on Aug. 17, 2002, and can be considered the foundation for the current SPCC program and this guide. Additional final amendments to the Phase I regulations were published on Dec. 26, 2006 (Fed. Reg. 77357) to address issues applicable to “small facilities” and “oil-filled equipment.” EPA issued the “SPCC Guidance for Regional Inspectors” to help explain how the Phase I amendments should be implemented. The latest regulations and guidance can be found on EPA’s web page at www.epa.gov/oilspill. All current EPA SPCC regulations and guidelines should be consulted before SPCC implementation.

To comply with the regulations, a company should conduct an engineering assessment of each power facility to determine the potential for oil discharge and the resulting impact.. This assessment is to be based on considerations of the volume of oil and the location of the facility relative to waters that may be affected. If a potential exists, the regulations require the preparation and implementation of an SPCC plan for all new and old facilities that could reasonably be expected to discharge oil into the navigable waters and groundwater of the United States or adjoining shorelines.

1.4 SCOPE OF AN SPCC PLAN

The SPCC plan should address both oil spill prevention and the measures to be employed in the event of a spill to control and contain the oil discharge. The plan should include:

- Physical description of facility and a facility diagram showing locations and contents of each container. (Containers smaller than 55 gallons do not have to be considered in the SPCC plan.)
- Type of oil in each container and its capacity
- Discharge prevention measures
- Discharge or drainage controls
- Spill countermeasures
- Methods of disposal of recovered materials
- Contact list and phone numbers
- Background information to aid reporting—facility address, location, phone numbers, etc.
- Prediction of the direction, rate of flow, and total quantity of oil that could be discharged as a result of major equipment failure
- Containment
- Inspections, tests, and records
- Personnel, training programs, and discharge prevention procedures
- Security

1.5 NEED FOR AN EFFECTIVE SPCC PLAN

Besides the necessity of compliance with EPA or state pollution regulations, any sizable oil spill from power facilities may carry serious consequences to the utility even though it may not be in close proximity to navigable waters. Damage suits, legal fees, penalties, and cleanup expenses may arise from oil releases onto neighboring properties and could have a costly impact on the utility. Adverse publicity from a spill migrating from the facility's property could impair the utility's ability to obtain future zoning or other permits, and could detract from the utility's goals of maintaining goodwill with its neighbors and protection of the environment.

CHAPTER 2 GENERAL INFORMATION CONCERNING SPCC PLANS

2.1 FACILITIES AFFECTED BY EPA REGULATIONS

Before an adequate spill prevention plan is prepared, the engineer first must be thoroughly aware of the requirements included in the EPA regulations. This and the next two sections should be consulted for an in-depth discussion of the EPA requirements and how they apply to power facilities.

Regulation 40 CFR 112, applies to all facilities engaged in drilling, producing, gathering, storing, processing, refining, transferring, distributing, using, or consuming oil products. To exclude facilities containing and using small quantities of oil, such as those used by homeowners, these regulations only apply if the facility meets the following conditions:

- a. Facilities with aboveground storage capacities greater than 1,320 gallons in aggregate storage. Containers of less than 55 gallons are excluded, or
- b. Facilities with a total storage capacity greater than 42,000 gallons of buried oil storage unless the facility is exempted because it is subject to all of the technical requirements of 40 CFR 280 or 281, or
- c. Facilities that, because of their location, could reasonably be expected to discharge oil into or on the navigable waters of the United States or its adjoining shorelines, or
- d. Locations required by the EPA Regional Administrator to have an entire SPCC plan, or applicable part, completed so that the purpose of the Clean Water Act is met.

2.11 Qualified Facilities - EPA created a subcategory of facilities known as “qualified facilities” that have the option of following certain streamlined regulations designed to reduce the burdens associated with the SPCC program. A qualified facility must **not** have had 1) a single discharge of oil to navigable waters exceeding 1,000 U.S. gallons or 2) two discharges of oil to navigable waters, each exceeding 42 U.S. gallons within any twelve-month period, in the three years prior to the SPCC plan certification date, or since becoming subject to 40 CFR part 112 if operating for less than three years. See 40 CFR Part 112.6 and 112.7

2.12 Small Qualified Facilities - If a facility has 10,000 gallons or less in aggregate above ground oil storage capacity and has an oil discharge history allowing it to be classified as a qualified facility, then an owner/operator of the facility:

- May prepare a self-certified SPCC Plan instead of one reviewed and certified by a Professional Engineer (PE)
- May meet tailored facility security and tank integrity inspection requirements without PE certification

- May prepare a plan which includes PE certified environmentally equivalent measures or impracticability determinations that would require PE certification for only the portions dealing with environmental equivalence and impracticability determinations. The remaining portions of the plan could be self-certified by the facility owner/operator.

213 Contingency Plan in Lieu of Secondary Containment for Qualified Oil-filled Operational Equipment - If a piece of equipment meets the definition of Oil-filled operational equipment at 40 CFR part 112.2 (e.g. transformers, capacitors and electrical switches) and has the oil discharge history required of a qualified facility, instead of providing secondary containment for that piece of equipment, the owner/operator may choose to prepare an oil spill contingency plan as described a 40 CFR Part 109. In addition, the owner/operator must prepare an inspection or monitoring program for detecting failure/release and a written commitment of manpower, equipment and materials to quickly control and remove discharged oil. Under this option it is not necessary for a PE to provide a written determination that containment is impracticable for this piece of equipment. (40 CFR Part 112.7(k)) Note: EPA has determined that generator sets may not be considered “oil-filled electrical equipment”. (71 Fed. Reg. No. 247, p. 77276).

Before the engineer decides to provide a 40 CFR Part 109 plan to **avoid** the requirement for secondary containment, the engineer should consider the burdens of maintaining an up-to-date Part 109 spill response plan and compare that approach to a decision to **accept** the general secondary containment requirement and use “active containment” measures, when appropriate, to satisfy those requirements. See Section 3.2, below.

The Agency recommendations are:

- a. Use of an oil spill contingency plan in lieu of oil retention systems: If the borrower’s engineer reviewing the facility determines that there is no likelihood of oil reaching navigable waters, it is responsibility of the borrower’s engineer to adequately show this in the SPCC plan and to include a step-by-step discussion of the cleanup procedures that will be used in the event of a spill. The borrower should be aware that possible serious consequences are associated with developing an SPCC plan around cleanup rather than prevention.
- b. Plans that employ general secondary containment should be prepared for:
 - Any facility that has the possibility of discharging oil into the groundwater
 - Any facility located in urban, suburban, or rural areas where adverse publicity could be detrimental in obtaining future zoning, building permits, etc.
- c. If pits, tanks, or ponds are used, they should be sized to hold at least 100 percent of the oil contained in the largest single piece of equipment plus a reasonable allowance for precipitation, and not be based on the total capacity of the facility. Berms and

equipment pits should be provided with a means to drain rainwater from the enclosures without possible loss of oil. This may be done by using polymer agents, manual valves, or any other acceptable means.

- d. The borrower's engineer should then identify the significant potential spillage areas and, based on prudent engineering judgment, eliminate small or insignificant sources of potential spills. This engineering judgment should carefully weigh the probability of the equipment spill occurrence and the magnitude of the probable spill size. This may result in the decision to employ secondary containment plans rather than spill contingency plans for such devices as current transformers, coupling capacitor potential devices, potential transformers, small station service transformers, and small reactors.

2.14 Small Qualified Facilities Containing Oil-Filled Equipment - A facility that contains "Qualified Oil-filled Operational Equipment" can also be classified as a "Small Qualified Facility", in which case the owner/operator may choose to self-certify the plan and use a spill response plan, monitoring and manpower commitment in lieu of secondary containment.

2.2 PERSONS RESPONSIBLE FOR SPCC PLANS

Individual SPCC plans should be prepared by the owner/operator of each facility that meets the above criteria. An SPCC plan also should be prepared for each mobile or portable oil storage facility, and must be applicable for any location to which this unit may be moved.

The owner/operator has the responsibility for preparing a plan covering each facility that could "reasonably be expected" to discharge oil into navigable waters or on adjoining shorelines. Among the factors that should be considered in making such a determination are:

- a. Prior spill history
- b. Location (proximity to navigable waters)
- c. Potential size of discharge
- d. Soil and terrain conditions
- e. Frequency and amount of rainfall.

2.3 NAVIGABLE WATERS

The term "navigable waters" is defined to include all of the following:

- a. Waters that are navigable, including adjacent territorial seas
- b. The entire river system extending upstream to its uppermost tributaries
- c. Lakes and ponds used by interstate travelers for recreational or other purposes
- d. Intrastate lakes, rivers, and streams from which fish or shellfish are taken and sold in interstate commerce
- e. Stream beds and riverbeds that normally may be dry and only contain water during heavy rain periods.

f. All wetlands.

This broad interpretation of “navigable waters” basically means that an SPCC plan must be prepared and maintained for any facility that may lead to the discharge of oil into any form of waters within the United States. This should include groundwater, sole source aquifers used for drinking water or other waters designated by your state for protection.

2.4 COMPLETION OF SPCC PLAN

SPCC plans are to be prepared and fully implemented before new facilities become operational. This implementation includes any construction or plant modifications, changes in operational maintenance or administration, or the training of personnel prescribed in the plan.

2.5 CERTIFICATION OF SPCC PLAN

Unless the plan was prepared and self-certified according to 40 CFR Section 112.6(a), each SPCC plan must be (according to EPA) reviewed, certified, and dated by a registered professional engineer (PE). The PE must state and attest familiarity with the provisions of 40 CFR 112, that he or his agent has examined the facility in question, that the plan has been prepared in accordance with good engineering practices, that procedures for required inspections and testing have been established, and that the plan is adequate for the facility. The owner/operator is responsible for final approval and implementation of the plan.

2.6 SAFEKEEPING OF SPCC PLAN

A copy of the SPCC plan must be (according to EPA) maintained at the facility for which the plan was prepared if the facility is manned four hours or more per day, or at the nearest field office if the facility is not so attended. The plan is to be available for EPA on-site inspection during normal working hours. It should be noted that the EPA will not evaluate SPCC plans for adequacy and/or completeness, but only as to whether a plan exists. However, if the facility experiences spill problems, the plan may be critically reviewed by EPA and by the appropriate state and local agencies to determine its adequacy. Based on this review, the EPA may require that the plan be amended to include additional preventive measures.

2.7 AMENDMENTS TO THE SPCC PLAN

The owner/operator is required to amend the plan when any of the following events occur:

- When required by the EPA after a review of the plan, submitted because of an oil spill
- Whenever there is a change in facility design, construction, operation, or maintenance that affects the potential for an oil spill
- Whenever a review by the owner/operator indicates that a more effective control and prevention technology will significantly reduce the likelihood of an oil spill
- Each SPCC plan must be reviewed every five years and be recertified by a registered professional engineer or by the owner operator if it was self-certified (see Section 2.1.2).

It is required that documentation of the completion of the review and evaluation be performed.

It may be necessary to contact federal or state oil regulatory agencies to confirm deadlines for the first and subsequent five-year SPCC plan amendment and the deadlines for implementing such amendments.

- 2.71 Plan** The owner/operator must (according to EPA) submit the SPCC plan and any amendments to the EPA and to the appropriate state agencies for their review whenever a facility experiences a single spill of 1,000 U.S. gallons of oil into navigable waters, or a discharge of oil in harmful quantities as defined in 40 CFR 110 in any two oil spills within a 12-month period.
- 2.72 Information to EPA, State** Within 60 days of the occurrence of either of the above situations, the owner/operator must submit to the EPA Regional Administrator and to the appropriate State agency in charge of oil pollution control the following information:
- a. Name of facility
 - b. Name of the owner/operator of the facility
 - c. Location of the facility
 - d. Storage capacity of facility (equipment)
 - e. Description of the facility, including maps of the site, oil flow path, and topographical maps
 - f. A copy of the SPCC plan with any amendments that address the facility that experienced the spill
 - g. The cause of the spill, including a failure analysis of the system
 - h. The corrective actions and/or countermeasures taken
 - i. Additional preventive measures taken or contemplated to minimize the possibility of recurrence
 - j. Other information as the EPA Regional Administrator may require.
- 2.73 EPA Review** EPA will review the information and any recommendations made by State agencies and may require the operator to amend the SPCC plan. If the EPA proposes any amendments to the plan, the operator will be notified either by certified mail or by personal delivery specifying the required changes. The amendment required becomes effective 30 days after notice, unless the operator appeals. The operator must implement the amendment as soon as possible, but no later than six months after the amendment becomes part of the plan. Within 30 days of receipt of the notice, the operator may submit written information and arguments to appeal any proposed amendment requirements. After considering all material presented, the EPA will either notify the operator that an amendment is required or rescind the previous notice.

A registered professional engineer must (according to EPA) certify all SPCC plan amendments, except those prepared and self-certified according to 40 CFR Section 112.6(a) and those proposed by an EPA Regional Administrator.

The owner/operator of facilities that violate the requirements of the EPA regulations relating to the preparation, implementation, or amendment of SPCC plans is subject to a civil penalty for each day that such a violation continues. The EPA Regional Administrator may assess or waive the civil penalties at his discretion. The penalty will not be assessed until the owner/operator has been given notice and an opportunity for a hearing.

CHAPTER 3 ELECTRICAL FACILITY APPLICABILITY

3.1 REGULATIONS

EPA regulations (40 CFR 112) were originally intended to prevent and control the discharge of oil from facilities directly involved with drilling, gathering, refining, storing, and consuming oil products for heating, cooling, and manufacturing purposes. EPA has included under the storage portions of these regulations electrical apparatuses that contain oil for electrical insulating purposes.

Electrical faults in this power equipment can produce arcing and excessive temperatures that may vaporize insulating oil, creating excessive pressure that may rupture electrical equipment tanks. In addition, operator errors, sabotage, or faulty equipment also may be responsible for oil release that may enter waterways.

3.2 FACTORS INFLUENCING THE EXTENT OF DAMAGE OF AN OIL SPILL

3.2.1 Factors The initial cause of an oil release or fire in electrical equipment may not always be avoidable, but the extent of damage and the consequences for such an incident can be minimized or prevented by adequate planning in prevention and control.

The risk of an oil spill caused by an electric equipment failure depends on many factors, including:

- Engineering and operating practices (i.e., electrical fault protection, loading practices, switching operations, testing, and maintenance)
- Quantities of oil contained within the equipment
- Station layout (i.e., spatial arrangement; proximity to property lines, streams, and other bodies of water)
- Station topography and site preparation (i.e., slope, soil conditions, ground cover)
- Rate of flow of discharged oil.

3.2.2 General Secondary Containment Each outdoor facility must be evaluated to select the safeguards commensurate with the risk of a potential oil spill. Appropriate containment and/or diversionary structures are required to prevent a release to navigable waters. For oil-filled electrical equipment, secondary containment must be sufficient to hold the oil so that no spill will escape the containment system before it is cleaned up. Examples of general secondary containment include

- Dikes, berms, or retaining walls sufficiently impervious to contain oil
- Curbing; culverts, gutters, or other drainage systems
- Oil/water separators
- Weirs, booms, or other barriers
- Spill diversion or retention ponds
- Sorbent material.

The secondary containment standard for bulk oil storage facilities is more restrictive than general secondary containment. Secondary containment for Bulk Oil Storage facilities is called “sized” containment and must be capable of containing oil from the largest single container at the facility plus sufficient freeboard to contain precipitation. Sized containment generally consists of dikes, containment curbs and pits.

3.2.3 Applicability to Electrical Facilities Oil-filled electrical equipment is subject to the requirements for “general” secondary containment as described at 40 CFR Part 112.7 which can include dikes and berms but can also include “sorberent material”. General secondary containment “may be either passive measures or active measures (countermeasures or land-based spill response capability) since both are designed to prevent a discharge from reaching navigable waters or adjoining shorelines. Passive [secondary containment] measures are permanent installations (such as dikes or berms) and do not require deployment or action by the owner or operator. However, permanent (passive) containment structures, such as dikes, may not always be feasible for certain oil-filled operational equipment (i.e. electrical transformers, capacitors, switches.) The owner or operator of an SPCC-regulated facility may instead use the flexibility of active containment measures to comply with the general secondary containment requirements for oil-filled operational equipment.” (71 Fed. Reg. 247, p. 77279, December 26, 2006).

Since active containment measures are designed to prevent a discharge from reaching navigable waters, they are much different than the Part 109 spill contingency plan which is designed to respond to a spill **after** it has reached navigable waters. See Section 2.4, above.

3.2.4 Active Containment Active containment measures are those that require deployment or other specific action by the owner or operator. Active containment measures “may be deployed either before an activity involving the handling of oil starts, or in reaction to a discharge so long as the active measure is designed to prevent an oil spill from reaching navigable water or adjoining shore lines. (71 Fed. Reg. 247, p. 77279, December 26, 2006). Examples of active containment include the use of storm drain covers, spill kits, and sorberent materials and the closing of valves. [EPA SPCC Guide for Regional Inspectors, 4-16 to 4-20.]

Agency Recommendation: Passive containment measures rather than active measures should be used for:

- Any facility that has the possibility of discharging oil into the groundwater
- Any facility located in urban, suburban, or rural areas where adverse publicity could be detrimental in obtaining future zoning, building permits, etc.

3.3 OIL CAPACITIES OF EQUIPMENT

In order to determine the size and type of electrical facilities that require an SPCC plan, it is necessary to know the oil capacities of each piece of electrical equipment at the facility.

3.3.1 Preparation Based on the quantities of oil stipulated in the regulations (i.e., 1,320 gallons aggregate storage of containers 55 gallons or greater), the following electrical facilities will probably require the preparation of an SPCC plan:

- Power plants
- Substations
- Switching stations
- Mobile substations
- Large customer installations
- Test facilities
- Pipe-type cables
- Equipment storage and maintenance facilities

3.3.2 Written Plans for Mobile Equipment SPCC plans that cover portable equipment and mobile substations should be written so that the plans will be applicable at any and all substation or facility locations.

BLANK PAGE

CHAPTER 4

GUIDELINES FOR PREPARATION AND IMPLEMENTATION OF AN SPCC PLAN

4.1 GENERAL

Detailed guidelines for the preparation and implementation of an SPCC plan are given in 40 CFR 112.7. In general, the plan should be carefully thought out, prepared in accordance with good engineering practices, and may follow the plan format presented in Section 112.7, although other formats are acceptable. While one may use other formats, such as State plans, integrated contingency, and other formats acceptable to the Regional Administrator, the alternate format must cross-reference its provision to the requirements listed in the SPCC rule. The alternate format must include all applicable SPCC requirements.

The overall objective of this engineering analysis study should be directed toward spill prevention by identifying facility weaknesses, and then designing and planning these facilities to prevent and/or greatly reduce the occurrence and effects of spills.

4.2 MAJOR SECTIONS OF AN SPCC PLAN

Following a detailed engineering review of the existing proposed facility, an SPCC plan should be developed that contains at least the following three major sections:

- a. Description of the facility, including topographical maps
- b. Identification of sources of potential spills
- c. Engineering description of the corrective actions to be taken to prevent a release and, if a release occurs, to contain the flow of oil before it reaches navigable waters or shorelines.

4.3 CONTENTS OF AN SPCC PLAN

The best method of presentation is that of a narrative engineering report with supporting maps and drawings. The description of the facility should be related to the plot plan of the facility, including details of drainage patterns and locations of waters that could be affected by oil discharges.

After defining the course of potential spills, the predicted maximum quantity and rate of spillage should be estimated and, using the topographical maps and available soil data, a prediction should be made as to the direction and the rate of flow.

Finally, the engineer must determine whether preventive measures should be provided for each source of spillage and, if so, in what form; or adequately show that spill prevention at the facility is not practical and discuss the necessary cleanup procedures. The solutions for the preventive type SPCC plan may vary widely, depending on the size, type, and general proximity of the facility to surface waters and the type of terrain and soil. The solutions may range from dikes, culverts, ditches, retention ponds, and curbs to various types of collecting systems.

4.4 SUBSTITUTION OF AN SPCC SPILL CONTINGENCY PLAN FOR REQUIRED PREVENTION MEASURES

Whenever an oil spill contingency plan is substituted for the required prevention measures under Section 112.7(d), the owner of the facility must demonstrate in writing and with drawings that Part 112 requirements are impractical and/or that there is no likelihood of the oil reaching navigable waters. "Impractical," as interpreted by EPA, means that measures are unsuitable for practical use at that facility and not merely uneconomical. In other words, it is not the owner's preference as to which type of plan to develop but, rather, it is totally dependent on whether adequate means are available for that particular facility. If it is determined that no prevention system is available, the cleanup type plan must discuss detailed cleanup procedures to include containment and removal. This latter method will not relieve the owner of the facility from liability costs, cleanup costs, and fines as a result of a spill. In fact, these costs may, in many cases, amount to many hundreds of times those costs associated with providing a protective system initially.

The Agency recommendations are:

- a. Use of cleanup procedures in lieu of oil retention systems: If the engineer reviewing the facility determines that there is no likelihood of oil reaching navigable waters, it is the engineer's responsibility to adequately show this in the SPCC plan and to include a step-by-step discussion of the cleanup procedures that will be used in the event of a spill. The borrower should be aware that possible serious consequences are associated with developing an SPCC plan around cleanup rather than prevention.
- b. Plans that employ general secondary containment should be prepared for:
 - Any facility that has the possibility of discharging oil into the groundwater
 - Any facility located in urban, suburban, or rural areas where adverse publicity could be detrimental in obtaining future zoning, building permits, etc.
- c. If pits, tanks, or ponds are used, they should be sized to hold at least 100 percent of the oil contained in the largest single piece of equipment plus a reasonable allowance for precipitation, and not be based on the total capacity of the facility. Berms and equipment pits should be provided with a means to drain rainwater from the enclosures without possible loss of oil. This may be done by using polymer agents, manual valves, or any other acceptable means.
- d. The engineer should then identify the significant potential spillage areas and, based on prudent engineering judgment, eliminate small or insignificant sources of potential spills. This engineering judgment should carefully weigh the probability of the equipment spill occurrence and the magnitude of the probable spill size. This may result in the exclusion of such devices as current transformers, coupling capacitor potential devices, potential transformers, small station service transformers, and small reactors.

4.5 USING SOFTWARE TO MODEL SPILLS

The Electric Power Research Institute (EPRI) has developed a software program that can be used to simulate the outcome of an oil spill within a substation. The Mineral Oil Spill Evaluation System—Multi-Phase Code (MOSES-MP) Version 3.0 software for Windows-based PC computers provides an easy-to-use method for predicting the likelihood of mineral oil spills from substations or other fluids from aboveground storage tanks reaching groundwater or nearby surface water. MOSES-MP also predicts the quantity of oil that infiltrates the ground beneath electrical equipment and provides soil saturation profiles at user-specified times. The effects of frozen days and fire events also can be evaluated. Options allow the user to quickly evaluate common mitigation alternatives, such as adding gravel and containment basins. Input data are entered using a series of menus. The software then generates graphs showing the volume of spills contained on-site, the depth of penetration of on-site spilled oil, the volumes reaching the water body surface, the travel time to reach the body of water, and the extent of any oil sheen on the water surface. Separate graphs can be produced for spills on dry days only, on wet days only, or for all days. A draft SPCC plan also is created that automatically incorporates site characteristics and simulation results into an editable text file. The SPCC Plan can be customized to include utility-specific information.

The one-dimensional processes of overland flow, based on a kinematic wave approach, consider on-site and off-site containments; evaporation; infiltration; surface slope; surface roughness and retention in open natural channels and in closed pipes; vegetation cover; thickness of viscous boundary layer; and effects of rainfall, frozen conditions, fires, and fire suppression on the flow of mineral oil. The two-dimensional processes of oil spreading over surface water bodies include those of advection, diffusion, and shoreline retention. The overland flow model uses a Monte Carlo approach for selecting input parameter values from user-defined ranges. The values used in the simulations for the cases where mineral oil reaches surface water can be saved as output files for later review. Input data also can be saved for use in later runs.

The Multi-Phase model uses a finite difference method for solving the Richards equation for nonaqueous phase liquid (NAPL) movement. The equations are solved for user-defined input values. The one-dimensional vertical movement of NAPL in the subsurface considers surface ponding, moisture effects, capillary pressure, relative permeability, and the NAPL properties of density, viscosity, and air/liquid interfacial tension. The enhanced MP code simulates surface spills and the redistribution of oil that has previously infiltrated into soil. The simulations can be made by specifying rainfall or a soil moisture profile.

BLANK PAGE

CHAPTER 5 CHEMICAL AND PHYSICAL PROPERTIES OF OIL

5.1 PROPERTIES OF OIL

Figure 5-1 lists some of the chemical and physical properties of a representative sampling of various types of petroleum products that may be found in a power facility and briefly relates how these properties affect spill behavior.

5.2 CHEMICAL CHANGES MADE BY OIL

Spilled oil interacts with the environment in several characteristic ways, some of which can be predicted from a knowledge of the oil composition and properties.

Spilled oil undergoes chemical changes such as oxidation. Oxidation under the influence of the ultraviolet rays of sunlight can eliminate a very thin oil slick. However, oxidation is a mixed blessing in that the hydrocarbons contained in oil may oxidize to oxygen-containing compounds that are more toxic than the oil.

5.3 BIOLOGICAL CHANGES TO OIL

The biological change process that oil undergoes involves the bacterial decomposition of oil. This metabolic decomposition of oil is the single most important natural cleanup operation.

Both chemical and biological processes are active when insulating oil and fuel oil are spilled. The importance of each depends on the type of oil and the environmental and temperature conditions under which the spill occurs.

5.4 NATURAL AND ENVIRONMENTAL CONDITIONS INFLUENCING THE DAMAGE FROM OIL SPILLS

In addition to the amount of oil spilled, environmental conditions present at the time of an oil spill can greatly influence the amount of damage that results. Calm water, a light breeze, and warm temperatures may favor rapid cleanup operations by fast evaporation rates and minimal mixing of the oil and the water. On the other hand, rough water conditions hamper cleanup operations by the thorough mixing of oil and water, forming an emulsion that impedes oil removal and allows oil to penetrate to greater depths.

A variety of natural processes occur when oil is spilled on water, which collectively will result in the weathering or aging of the oil. These processes include spreading, evaporation, dissolution, emulsification, chemical reaction, and biological degradation. These processes tend to disperse the oil and eventually lead to its dissipation or removal from the environment.

<u>Property</u>	<u>Description</u>	<u>Average Crude Oil</u>	<u>Casoline</u>	<u>Products Diesel #2</u>	<u>Fuel Oils #5 #6</u>	<u>Lube Oil</u>	<u>Insulating Oil</u>	<u>Relationship of Property to Spill</u>
Viscosity (Centistoke at 100°F)	Resistance to flow	Can range from low to high	Low	Low (1.4-2) 3.0	High (75) High (75)	Mod-high	Mod (60)	Low viscosity materials spread easily over surface.
Surface Tension	Resistance to spread over another liquid	High	Low	High High	High High	High	Mod (46)	Low surface tension materials spread more rapidly.
Volatility	Tendency to evaporate	Low - (some components)	High	Low Low	Very Low Low	Very Low	Low	High volatility favors evaporation; if combined with low flash point, presents explosion hazards.
Relative Solubility	Tendency for all or part of a spill to dissolve in water	Very low	Very Low	Very Low Low	Very Low Low	Emulsifies	Low	Most petroleum products have some readily soluble components (including additives) that may be toxic to aquatic organisms.
Density (specific gravity)	Mass per unit vol. Tendency to sink in water	Med-high (0.85-0.95)	Low (.73)	Low Low (.85) (.82)	Mod High (.86) (.96)	Mod (.85)	Mod (.89)	Materials heavier than water (sp. Gr = 1.0) generally will sink. Materials near 0.9-1.0 sp. Gr may tend to "float" under the surface.
Emulsibility	Tendency to form stable suspension with water	Low-high	Very Low	Low Low	High High	High	Low	High emulsibility spreads oil throughout water column; extends possible contamination range.
Pour Point	Lowest temp. at which oil will pour	Low	Low	Low Low 20°F 20°F	High 60°F	Low 10°F	High 67°F	As pour point is approached, spill spread rate decreases.
Flash Point	Temp. at which ignition occurs	Mod.	Very Low (-40°F)	Mod. (100)	High (130)	Very high (350)	Very high (300)	Low flash point combined with high volatility in confined area creates explosion hazard.

Figure 5-1
Some Properties of Petroleum Products That Affect Spill Behavior

5.4.1 Spreading Process

By far the most important of these processes is the spreading of the oil to a thin film, for without this happening first, many of the other dispersive processes would not occur or would only happen at greatly reduced rates. Paradoxically, it is this same tendency to spread rapidly that may cause the oil spill to “get away” from cleanup personnel.

Two important driving forces that cause oil to spread on water are gravity and surface tension. The fact that oil is lighter—less dense—than water brings the force of gravity into action. Oil is a complex mixture of many varying compounds, each of which may have a different density. On the average, insulating oil will have an overall density that is about 90 percent of the density of water.

To understand the role of gravity in the spreading process, it is useful to consider floating oil confined by some type of barrier such as an oil drum constructed from a plastic with a density identical to that of oil (Figure 5-2).

This full barrel will have the density of oil that means 90 percent of its volume will be below the water’s surface, and 10 percent above. The floating oil extends a height (h) above the surface of the water. At any point in the oil surface at the level of the water surface, there is a pressure (p) that is attributed to the weight of the oil above the water surface.

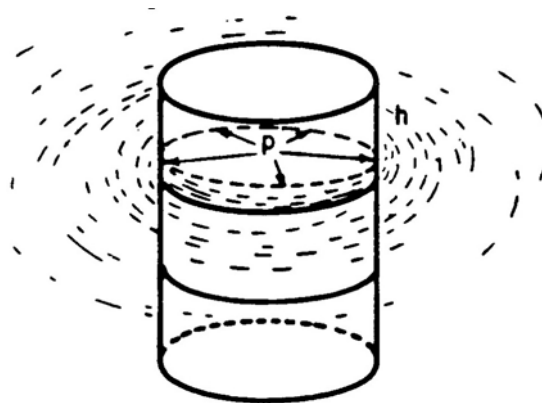

Figure 5-2: A Hypothetical Floating Barrel of Oil

Now imagine that the plastic is rapidly disintegrated by the water and the drum is no longer there to confine the barrel of oil. The uniform pressure just above the surface of the water becomes an unopposed force toward the sides of the (missing) drum, and the oil will spill out over the surface of the water, as indicated by Figure 5-3. Since weight is removed as the oil above the surface spills away, the oil below the surface floats higher in the water, causing more spillage to the sides. Consider also that the height above the water continues to decrease and the sideways force from the gravitationally induced pressure decreases with (h). The initial value of (h) and, hence, the initial gravitational spilling force depends on the volume of oil spilled. Thus, large spills spread more rapidly, and decrease with time.

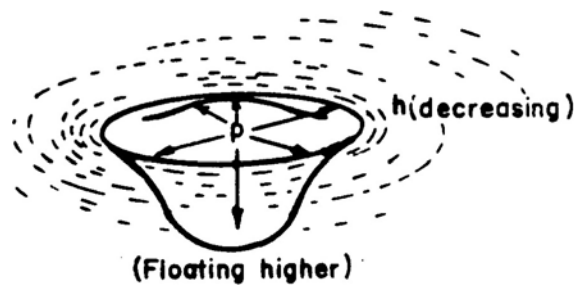

Figure 5-3: Oil Spreading

It is important to consider the kinds of forces that oppose spreading forces because spreading will cease when the driving and opposing forces are balanced. In the early phase of a large spill, the major opposing force is simply the natural tendency of the oil to remain at rest, its inertia. However, as the gravitational driving force lessens with the decreasing thickness of the floating oil, the opposition from the oil's viscosity and its drag when sliding becomes important. The initial two phases are known as gravity inertial spreading and gravity viscous spreading.

When the slick from oil has thinned to about 0.08 cm (0.03 in.), the gravitational spreading force ceases to be a major factor and surface tension effects, which were negligible before, become the dominant driving force.

The concept of surface tension can be explained in terms of the forces between the molecules of a liquid. A molecule in the interior of a sample of liquid experiences attractive forces from the molecules that surround it. A molecule on the surface of the liquid experiences an unbalanced force because of attractions with molecules to the sides and below it and the nonexistent or very weak interactions that it has with the vapor molecules above the liquid surface. Thus, surface molecules experience a net force that pulls them toward the interior. If the amount of surface area is somehow increased—a bubble grows, a flat surface curves—something must take place to bring molecules from the interior to the surface. The opposition that must be overcome to create additional surface is called the surface tension. Wherever there is an interface—such as between water and air, oil and air, or oil and water—a surface tension characteristic of the interface will exist.

It would be quite advantageous to be able to make accurate predictions about spreading rates during this final or surface tension-viscous phase of spreading because all unchecked spills will eventually spread by this mechanism. Small spills, which are far more frequent, will spread solely because of surface tension. Unfortunately, it is almost impossible to make valid predictions for many situations because the spreading coefficient will vary with time.

The evaporation and dissolution of the lighter components of the oil will change as properties such as surface tension, density, and viscosity change.

The ambient temperature is important in the surface tension phase of spreading but has only a small effect during gravity-forced spreading. For example, at arctic seawater temperatures near

20° F, the spreading coefficient is approximately zero, and the oil will not spread to a thin film. Also, the rate of evaporation and dissolution will increase as the temperature increases. The evaporation of the lighter oil products, with time, will usually lead to slicks that are nonhomogeneous and have thick and thin regions, as shown by Figure 5-4.

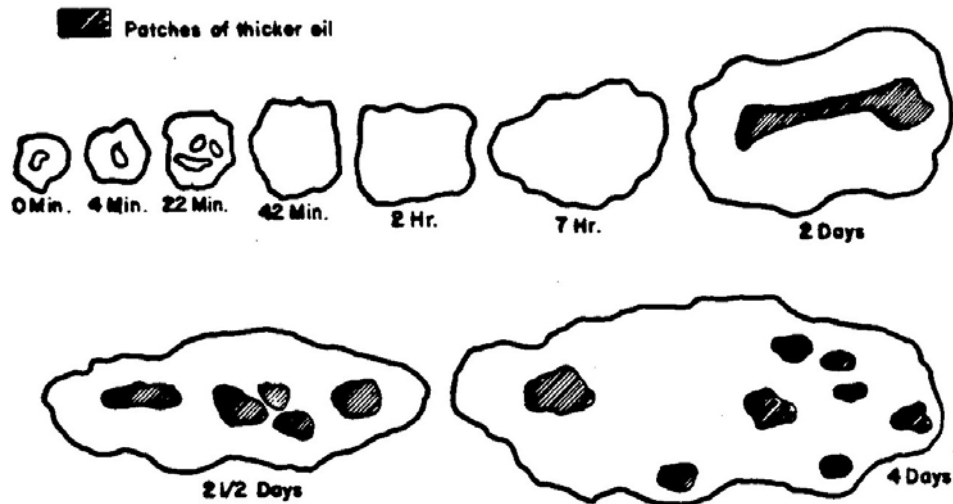

Figure 5-4: Development of an Oil Slick

The preceding discussion of the spreading process occurring in calm water is an idealization, since wind, waves, and water currents are not considered. Currents and wind will displace the entire growing slick from its original location, to include some modification of the shape of the slick—Figures 5-5, parts A, B, and C; whereas wave motion coupled with currents will break a slick into patches and windrows—parts D and E of Figure 5-5.

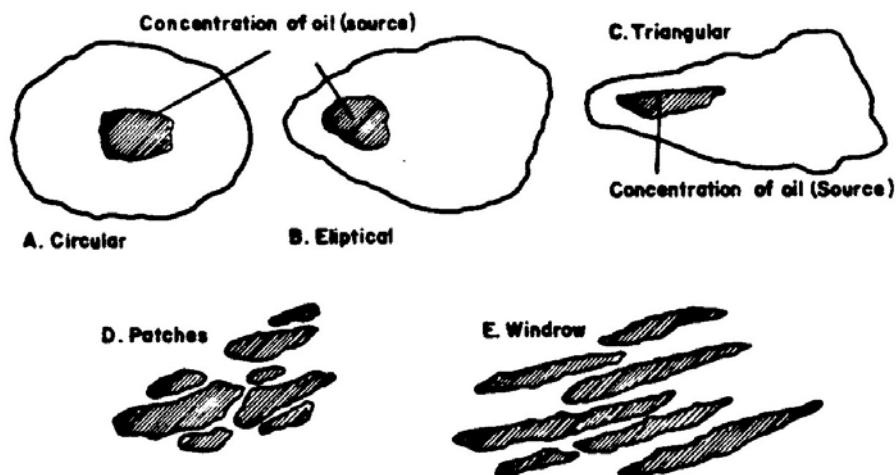

Figure 5-5: Typical Spill Distribution Patterns.

A: Quiet Water—Unrestrained Spill. B: Mild Current or Wind. C: Strong Current or Wind. D: Light Oil—Moderate Wave Action. E: Swift Current-Wave Action.

A useful rule of thumb is that the center of a slick will migrate with any current at the speed of that current and also will drift in the wind direction at about 3 percent of the wind speed. Laboratory measurements indicate that the drift may actually vary from 2.5 percent to 4 percent of the wind speed.

5.4.2 Agitation and Disposal of Oil Slicks

The agitation of oil slicks because of the breaking waves in rough water and the action of surf can be effective in supplying the energy to form the small droplets of stable emulsions and then disperse them. Such oil particles—ranging in size from 0.0002 in. to 0.1 in.—have been found in the water as far as 150 miles from an original spill.

There also are data indicating that aerosols of oil droplets in air can be formed by the action of wind and waves in producing spray.

5.5 THE BEHAVIOR OF OIL WHEN USING BOOMS

When deployed for oil containment in streams or channels, booms will form a ‘U’ shape open to the current so that the oil will collect at the bottom of the ‘U.’ The force of the moving current tends to confine the oil at the bottom of the ‘U’, placing the deepest part of the floating oil there. A vertical cross section would show the oil mass to be wedge-shaped, with its thinner leading edge toward the open mouth of the ‘U’ of the boom. The boom needs to float sufficiently high above the water to prevent the oil from splashing over the top of it with normal wave action. Booms also need to extend deep enough into the water to hold the oil at nominal currents.

It is useful to remember that the average insulating oil will have a density similar to that of ice, which is about 90 percent of water’s density. Thus, a pool of oil, like an iceberg, is 90 percent below the water surface. If the boom draft below the water surface is one-half foot, the current pushing the oil against the bottom of the ‘U’ cannot exceed 1.78 ft./sec.—about 1 knot—without the oil running under the bottom of the barrier, a phenomenon called “drawdown.”

Booms require a greater draft to contain oil in currents greater than 1 knot. However, at about 0.75 knots, a phenomenon occurs and a “head-wave” develops on the underside of the leading edge of the wedge of oil (Figure 5-6). At currents between 0.75 knots and 1.5 knots, droplets are broken off from the turbulent backside of the head-wave. If the slick is long enough, the majority of these droplets will rise and rejoin the oil pool. At currents greater than 1.5 knots, the majority of the drops escape by running under the barrier, and increasing a boom’s draft will not prevent this type of slow leakage. A towed boom experiences essentially the same forces as a stationary boom in a current at towing speeds greater than 1.5 knots; droplet drop-off with run-under occurs. In fact, if a boom is towed against a current, the sum of current velocity and towing velocity cannot exceed 1.5 knots without run-under occurring.

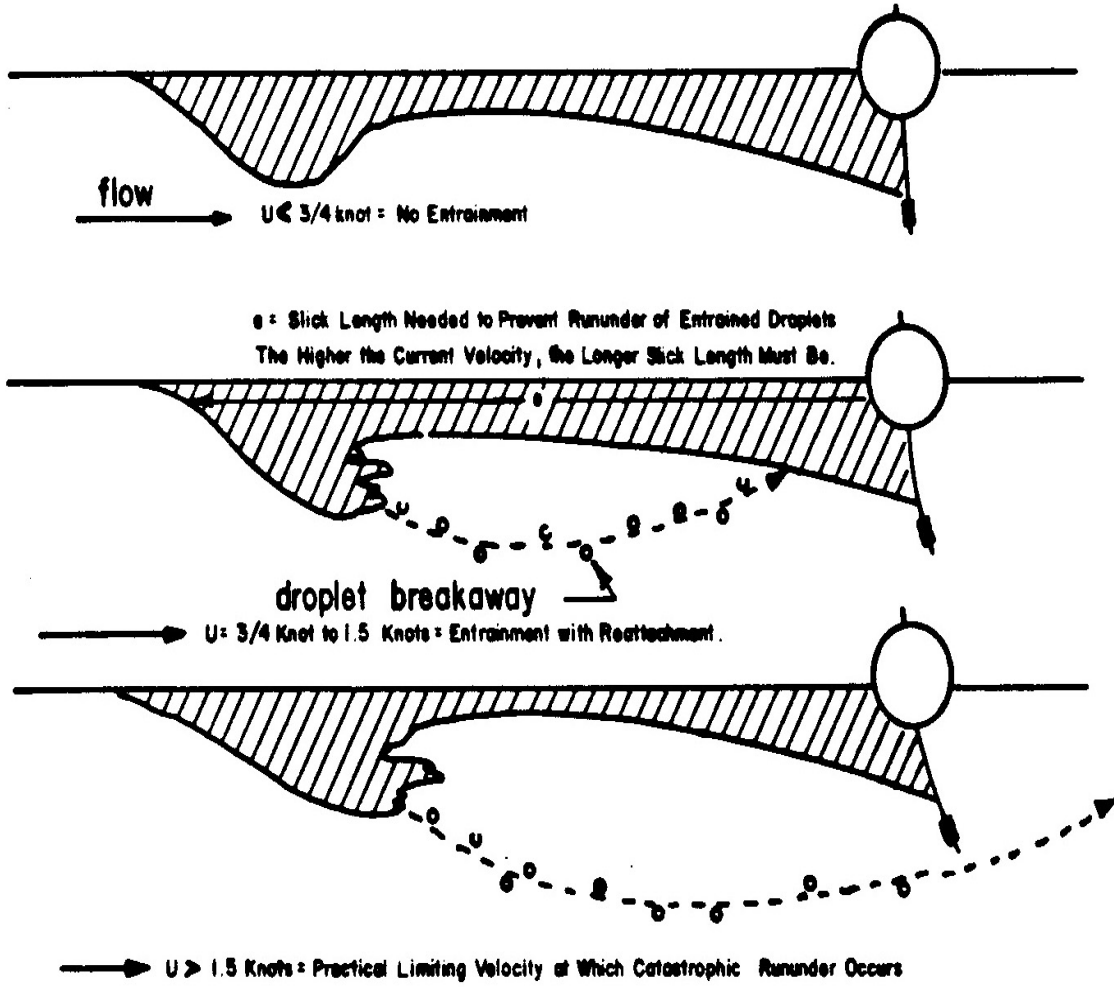

Figure 5-6: Entrainment Failure

BLANK PAGE

CHAPTER 6 OIL SPILL PREVENTION TECHNIQUES

6.1 OIL RETENTION SYSTEMS

Once a need for an oil spill prevention system is determined, an engineer must weigh the advantages and disadvantages that each oil retention system may have at the facility in question. The oil retention system chosen should balance the cost and sophistication of the system to the risk of an oil spill reaching navigable waters/environment. The risks will depend on such things as soil, terrain, relative closeness to waterways, location with regard to property owners, and potential size of the discharge. Each of the systems described below should be considered based on their relative merits to the facility under consideration. One system will not always be the best choice for all situations and circumstances.

6.2 YARD SURFACING AND UNDERLYING SOIL

Four to six inches of rock gravel surfacing are normally required in all electrical facility yards. This design feature benefits the operation and maintenance of the facility by providing proper site drainage, reducing step and touch potentials during short circuit faults, eliminating weed growth, improving yard working conditions, and enhancing station aesthetics. In addition to these advantages, the gravel will aid in fire control and in reducing potential oil spill cleanup costs and penalties that may arise from Federal and State environmental laws and regulations.

Yard surfacing should not be considered the only method of secondary oil containment without further study dependent on the volume of oil, yard surface area, and slope of substation. It can also be considered as a backup in limiting the flow of oil in the event that the oil containment system fails.

Soil underlying power facilities usually consists of a nonhomogeneous mass that varies in composition, porosity, and physical properties with depth. The soil's drainage characteristics—permeability—are of primary concern in the design of an oil containment facility. The permeability coefficient, “k”, is a measure of the capacity of the soil to conduct or pass water under a unit hydraulic gradient. Coarse grained soils are more pervious and have corresponding higher permeability coefficients than fine grained soils. Using the coefficient of permeability, “k” and the hydraulic gradient, “i”, the flow volume “V”, discharged through the soil's cross-sectional area, “A”, during time, “t” may be estimated as follows:

$$V=kiAt$$

where:

V = volume discharged through the soil, cm³

k = coefficient of permeability, cm/s

i = hydraulic gradient, cm/cm

A = cross sectional area of soil conveying flow, cm²

t = time, seconds

Soils and their permeability characteristics vary widely as indicated below:

<u>Permeability Coefficient (cm/sec)</u>	<u>Degree of Permeability</u>	<u>Type of Soil</u>
Over 10^{-1}	High	Stone, gravel, and coarse- to medium-grain sand
10^{-1} to 10^{-3}	Medium	Medium grain to uniform, fine sand
10^{-3} to 10^{-5}	Low	Uniform, fine to silty sand and sandy clay

6.3 PIT LINERS AND SEALERS

Pits with liners or sealers may be used as part of an oil containment system capable of retaining any discharged oil on-site for an extended period of time. Any collection or containment pit should be constructed with materials having medium to high permeability—above 10^{-3} cm/sec—and should be sealed in order to prevent migration of spilled oil into underlying soil layers and groundwater. These surfaces may be sealed and/or lined with any of the following materials:

- a. Plastic or rubber—Plastic or rubber liners may be purchased in various sizes and thickness. Consideration should be given to the selection of a liner that is not subject to mechanical injury that may occur as a result of construction, installation, equipment, chemical attacks on surrounding media, and oil products.
- b. Bentonite (clay)—Clay and bentonite may be used to seal electrical facility yards and containment pits. These materials can be placed directly in four- to six-inch layers or may be mixed with the existing subsoil to obtain a soil permeability of less than 10^{-3} cm/sec.
- c. Spray-on fiberglass—Spray-on fiberglass is one of the most expensive pit liners available, but in some cases the costs may be justifiable in areas that are environmentally sensitive. This material offers very good mechanical strength properties and provides excellent oil retention.
- d. Reinforced concrete—Four to six inches of reinforced concrete also may be used as a pit liner. The advantage of this material is that it is readily available at the site at the time of initial construction of the facility. The disadvantages of this material are that initial preparation is more extensive and materials are not as easily workable as some of the other materials.

If materials other than those listed above are used for an oil containment liner, careful consideration should be given to not selecting materials—such as asphalt—that may dissolve or become soft with prolonged contact with oil.

The final selection of pit liners or sealers should be based on cost, strength, and durability.

6.4 SUBSTATION DITCHING

One of the simplest methods of providing total substation oil spill control is the construction of a ditch entirely around the outside periphery of the station (Figure 6-1). The ditch should be large enough to contain all surface runoff from rain and insulating oil. Such ditches may be periodically drained by the use of valves. Here again, the method discussed in the previous section should be used in determining the allowance for precipitation.

a. Advantages

- Economical

b. Disadvantages

- Periods of heavy rain may not provide adequate containment.
- Standing pools of water may breed insects.
- May not be feasible in porous soil areas.

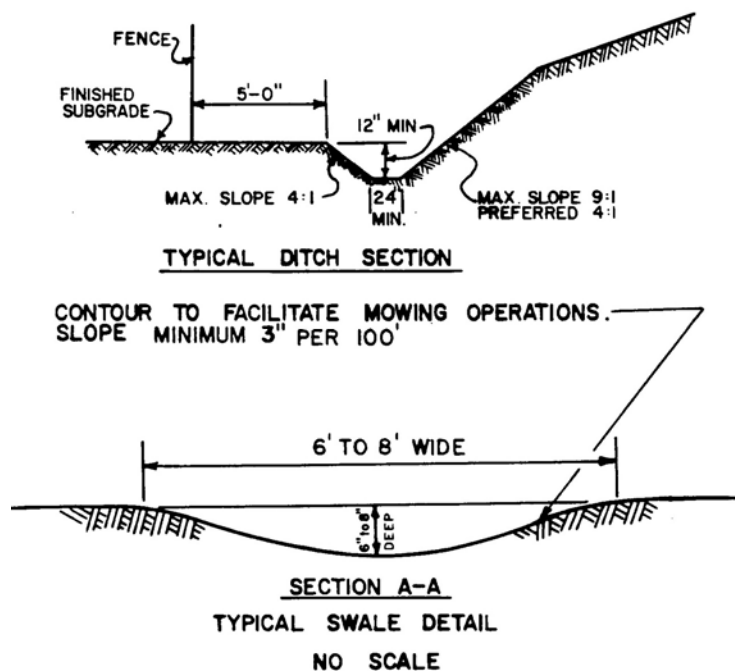
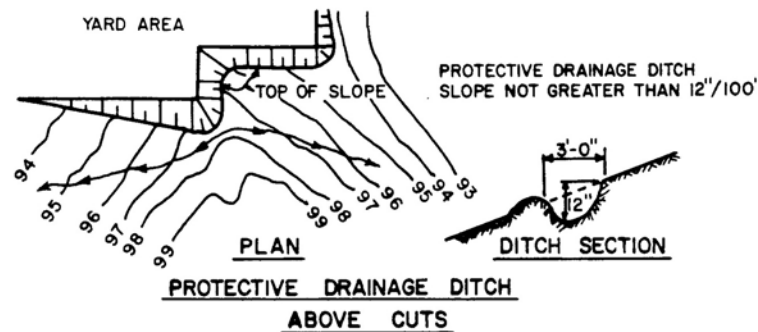

Figure 6-1: Methods of Ditch Construction

6.5 COLLECTING POND WITH TRAP

This system consists of a collection pit surrounding the protected equipment, drains connecting the collection pits to an open containment pit, an oil trap that is sometimes referred to as a skimming unit, and the discharge drain. This system is shown in Figure 6-2.

The collection pit surrounding the equipment is filled with rocks and is only deep enough to extinguish burning oil. The bottom of this pit is sloped for good drainage to the drainpipe leading to an open containment pit. This latter pit is sized to handle all the oil of the largest piece of equipment in the station. A cross section of the system is shown schematically in Figure 6-3. The trap shown in Figures 6-4 and 6-5 is designed to contain the total capacity of oil on top of the water.

To maintain a dry system in the collecting units, the other side of the intake pipe from the containment pit should be at least the maximum elevation of the oil level. In areas of the country subject to freezing temperatures, the trap, or skimmer, should be encased in concrete, or other such available material, to eliminate heaving as a result of ice action.

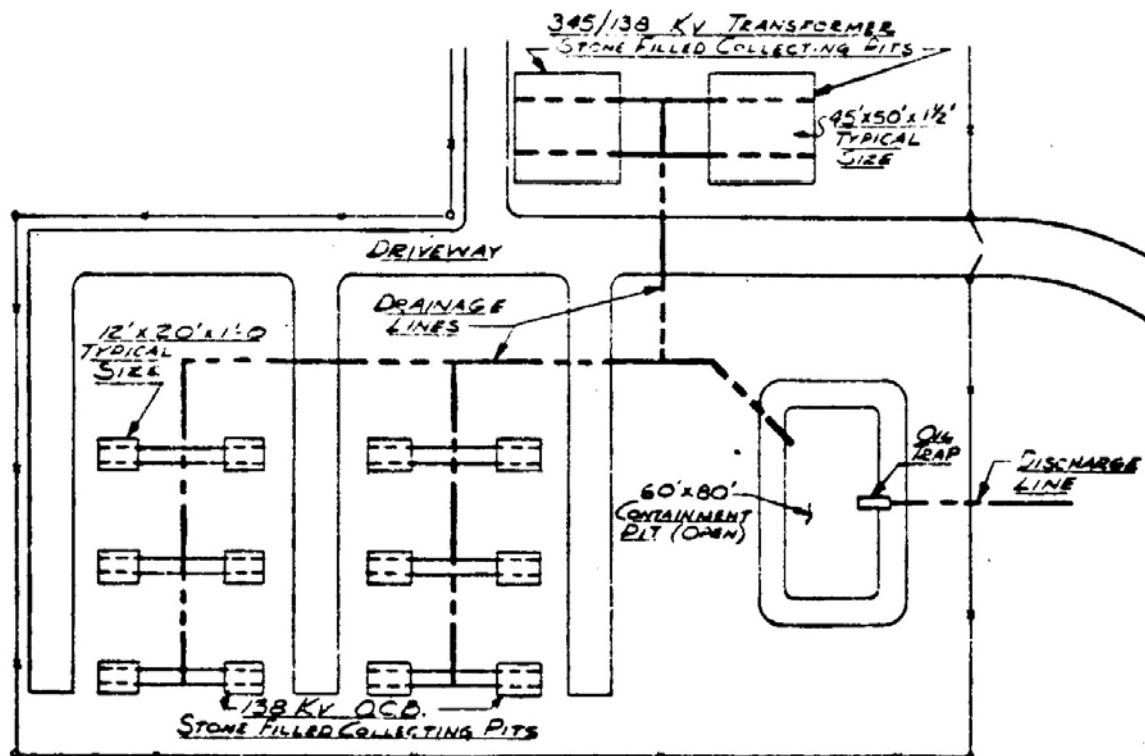

Figure 6-2: Typical Oil Drainage System for 345/138 kV Outdoor Substation

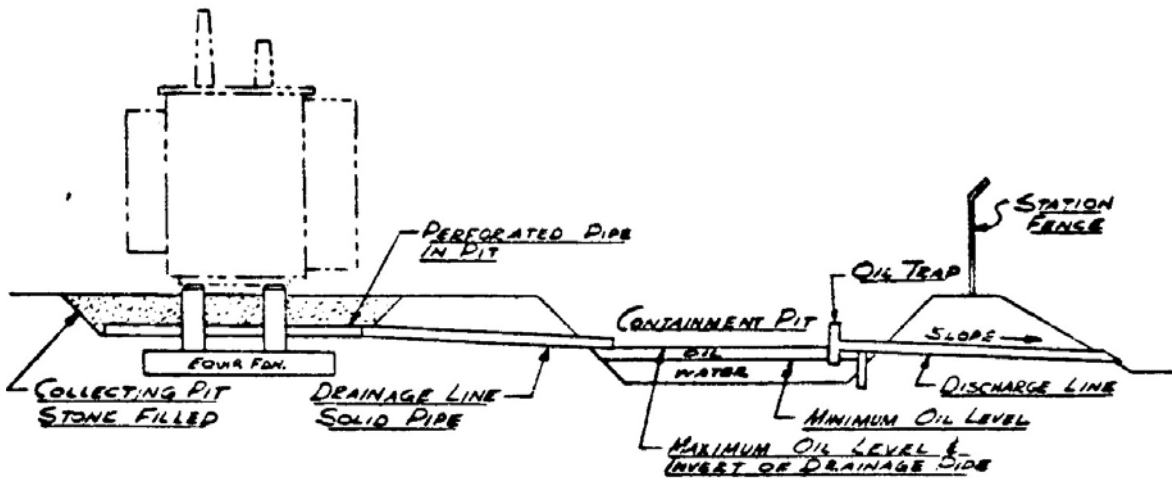

Figure 6-3: Cross Section of Oil Drainage System

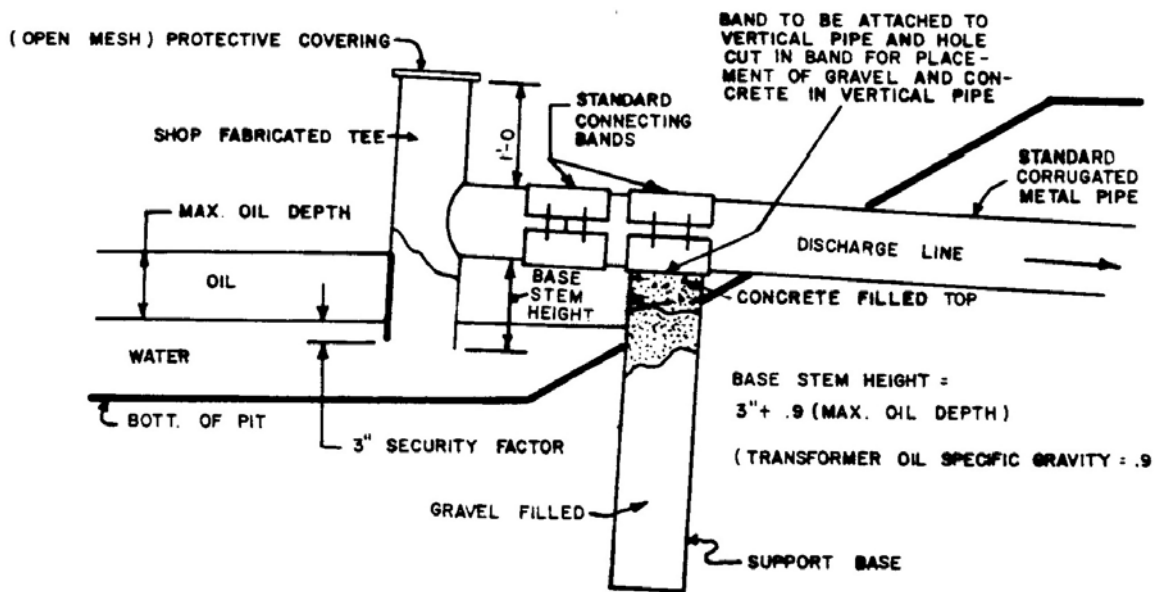

Figure 6-4: Oil Trap or Skimming Unit

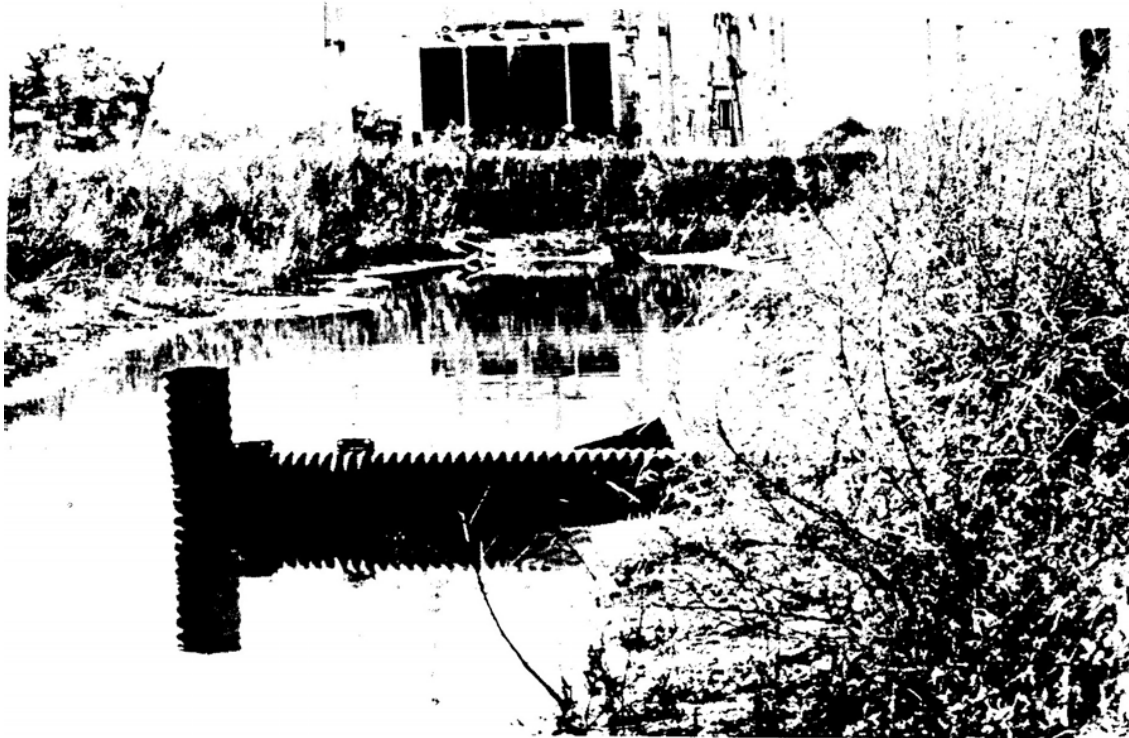

Figure 6-5: Oil Trap in Containment Pit

An alternate method of constructing an oil trap is shown in Figure 6-6. The trap in this method is fabricated with three- to four-inch PVC pipe. Galvanized pipe is not recommended for use for subsurface work because of corrosion and subsequent loss of the pipe.

a. Advantages

- Relatively inexpensive
- Easily maintained
- Provides additional substation drainage
- Reliable

b. Disadvantages

- More substation area required
- Unsightly, possible hazard to personnel and equipment movement
- May have possible insect breeding problems

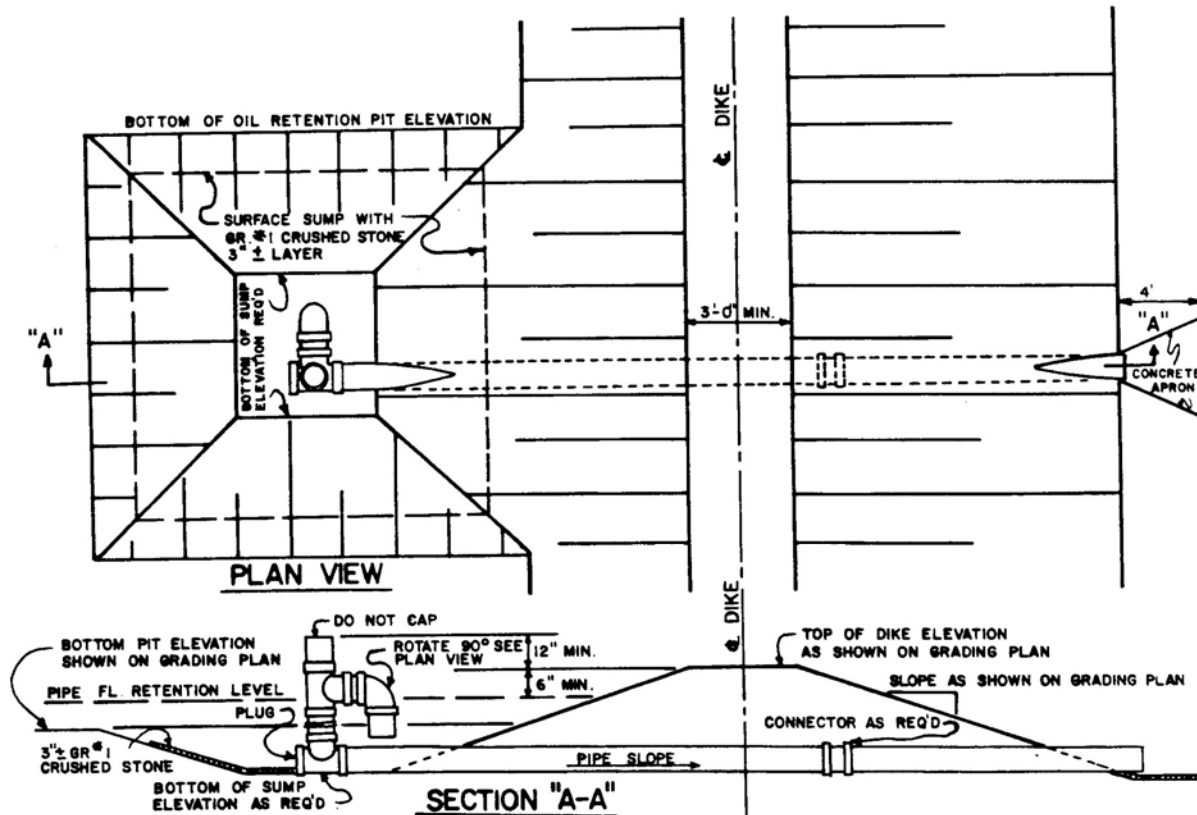

Figure 6-6: Oil Trap Construction Using Galvanized or PVC Pipe

6.6 POLYMER AGENTS

6.6.1 Imbiber Beads®* Imbiber Beads® are spherical plastic particles, each about the size of a sugar granule, that are engineered to imbibe/absorb a wide range of compatible organic liquids, including diesel fuel, gasoline, hydraulic fluids, crude oil, aviation fuels, chlorinated solvents, cable oils, and most transformer oils. Imbiber Beads® are unique to the entire sorbent industry in that liquids physically diffuse into their solid structure, which causes them to swell up to three times their original size. In doing so, they will absorb up to 27 volumes of liquid for each volume of Imbiber Beads®. Once a liquid is “imbibed,” it is no longer available for release back into the environment. This has decided benefits during spill response operations, as secondary contamination is eliminated—saving both time and money—and potentially hazardous vapor release is reduced by 500 percent to 600 percent that of other sorbent (adsorbent) materials. Imbiber Beads® also are unaffected by water and will selectively remove oils from water.

The swelling characteristic of Imbiber Beads® allows them also to be used in preventive measures such as gravity-flow drain protection in areas at risk, such as transformer substations, motor pools, fueling areas, storage areas, service yards, and bulk storage tanks. Water will percolate through the void spaces between the Imbiber Beads but when contacted by a

* Imbiber Beads® is a Registered Trademark of Imbibitive Technologies Corporation

compatible oil product the Imbiber Beads[®] swell, effectively closing off the leak path and sealing the drain.

Imbiber Beads gravity-flow drain protection systems are available in various sizes and design configurations to accommodate a wide range of requirements, including flow rates. The systems are all-inclusive and consist of a standard size, galvanized or stainless steel housing and various component parts, all of which are easily changed out either following a release event or as part of routine maintenance.

1. Top grate with silt fabric cover for silt collection and various debris
2. Imbiber Beads/Sand Discs (2) to absorb incidental amounts of oil along with silt filter cover
3. Imbiber Beads “pillows” to absorb run-off amounts of oil—up to three gallons
4. Imbiber Beads Shut Off Disc (1)—14" diameter containing bulk Imbiber Beads

The Imbiber Beads Disc provides a positive shutoff mechanism in the event of a catastrophic release. These systems have no moving parts and require no electronic sensors or electricity. (Figures 6-7 and 6-8).

A similar Imbiber Beads gravity-flow drain protection system also is available to allow water to drain from diked or curbed areas but still provide protection in the event of a release. The Imbiber Beads curb system is designed to be inserted into a cutout section of the curb or dike wall (Figure 6-9).

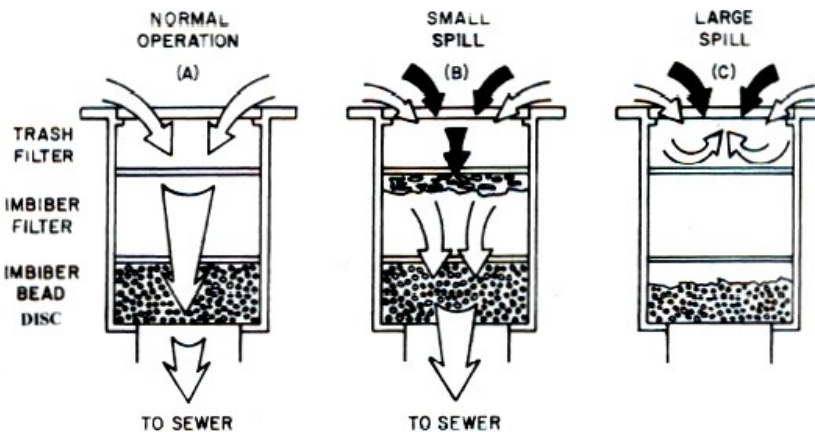

Figure 6-7: Imbiber Beads[®] Gravity-Flow Drain Protection System—Operational Process

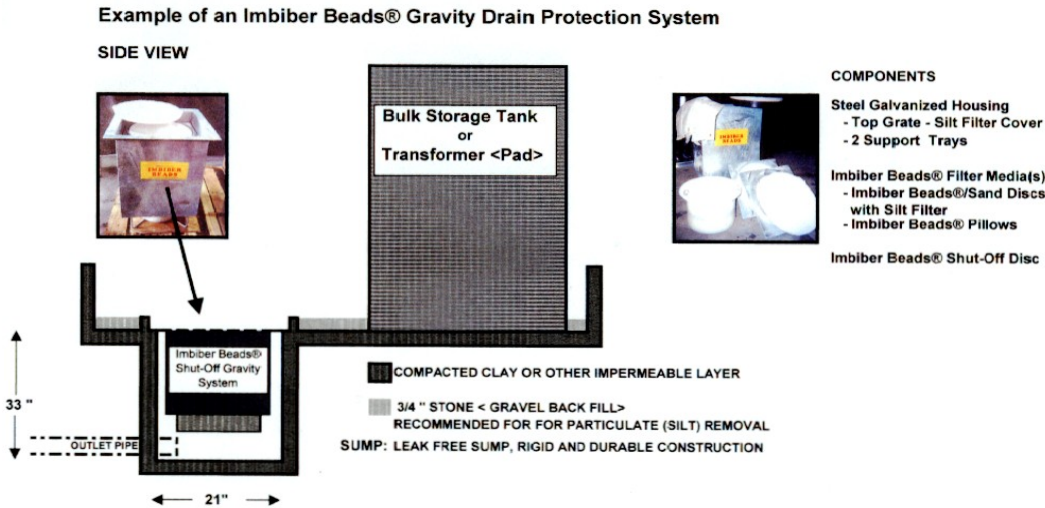

Figure 6-8: Example of an Imbiber Beads® Gravity Drain Protection System



Figure 6-9: Imbiber Beads Gravity-Flow Drain Protection System—Curb Application

Other Applications:

Imbiber Beads “spin-on” valves are used in conjunction with oil-water gravity flow separators for the safer discharge of water from these separators. The spin-on valves are available in plastic (100 percent HDPE) and fasten to a 2" outlet pipe. Imbiber Beads pillows and blankets are used in “sit and soak” situations as preventive maintenance where oils and fuels are known to collect or where weeps occur. They also are used to prevent oil releases that could cause a visible sheen on surface waters at outfalls.

6.6.2 CI Agent

CI Agent is a nontoxic, nonhazardous, noncorrosive, noncarcinogenic, environmentally friendly petroleum-based blend of polymers, used to immobilize petroleum and related petrochemical emergencies related to releases on land and water.

CI Agent is a dry granular powder specifically blended to encapsulate petroleum-based liquid spills through the rapid transformation of a liquid material into a cohesive rubber-like mass upon contact. It has met all the criteria for being listed on the Environmental Protection Agency’s National Contingency List Product Schedule. Unlike absorbents that soak up a liquid through expansion, CI Agent solidifies the liquid into a removable mass with minimal volumetric

increases and retains the liquid for easier removal. This eliminates the “dripping” effect that results when absorbent materials do not allow the liquid to escape or to be squeezed out, thus greatly minimizing any residue or contamination.

The application rate may vary with the viscosity of the liquid; however, to solidify a hydrocarbon normally requires a ratio of 4 to 1 CI Agent. The pickup ratio and speed of solidification will vary with the type of hydrocarbon, the amount of volatiles remaining, temperature, and the viscosity of the liquid.

Solidification capacity of one pound and one gallon of CI Agent:

Hydrocarbon Tested	Capacity of One Pound	Capacity of One Gallon
Gasoline	5.42 lbs	2.3 gallons
Diesel	4.89 lbs	2.1 gallons
10w30 Motor Oil	1.64 lbs	0.7 gallons
Transformer Oil	4.01 lbs	4.5 gallons
Enamel Paint	1.54 lbs	0.7 gallons

The product can be purchased in a variety of forms:

6.6.2.1 CI Agent barrier booms allow utility companies to quickly and easily boom all or part of their perimeters to help meet federal SPCC regulations of secondary containment and diversion at a fraction of the cost of alternative methods. CI Agent barrier booms will not allow a hydrocarbon to leave the facility, while allowing water to pass through. Should an oil release occur, the booms will instantly solidify the oil, thus becoming an impervious barrier to keep the oil on the property, until the incident can be responded to.

6.6.2.2 CI Agent barrier mats afford the same protection and can be quickly and inexpensively placed around the slab of a pad mount or other pad-mounted equipment, to contain any leaks or to stop releases from reaching the soil or leaving the immediate area. All CI Agent barrier booms and mats are custom-designed and manufactured to meet customer specifications.

6.6.2.3 CI Agent hydrocarbon flow barriers (HFBs) easily become a preventive method at new or existing gravity-flow drains at any type facility. HFBs allow rainwater to pass but collect any low parts per million of sheen from the water. HFBs also close down drains when activated by a major oil release. An HFB is available in all types of design, including curb and dike configurations, various flow rates, and size requirements to accommodate a wide range of applications. Requiring no electricity and having no moving parts, CI Agent HFBs become a cheap insurance policy against accidental spills or catastrophic releases.

6.6.2.4 CI Agent in loose powder form can be used for water- or land-based spills. CI Agent floats on the surface of the water and will not sink even after it has encapsulated a liquid. If a spill is emulsified to the point of sinking, CI Agent could be introduced below the level of the spill and as it rises to the surface will pass through the emulsified waste and bring it to the surface in an encapsulated form, thus easing the complexity of recovery. The suggested method of dealing with an open water spill would be to completely surround the spill with CI Agent,

spreading the product on the outer edge of the spill. If the normal absorbent (leaching type) booms have been used, use CI Agent as a barrier between the booms and the spill to prevent the spill from reaching the booms. Once the spill is contained, the liquid inside the CI Agent can either be recovered for reclamation or additional CI Agent can be spread over the entire spill for complete solidification, and ease of removal with the least amount of waste.

For land-based spills, CI Agent can be used for building a perimeter or dike around the spill to prevent further migration of the liquid into drains, ditches, or waterways. This presents the opportunity to reclaim the liquid. If full immobilization is necessary, CI Agent can be broadcast over the entire area to form a cohesive, rubber-like "carpet" for easy removal by shovel, loader, or other suitable method and placed in waste disposal or end-use application containers.

6.7 OIL SEPARATOR TANK

This system is feasible only when there is sufficient gradient for gravity discharge from the underground tank. The oil and water are collected from the equipment area and are discharged into an oil separator tank. The principle upon which this system operates is that oil is lighter than water and floats above it.

The oil separator tank should be designed to contain all of the oil in the largest single piece of equipment should a major rupture occur (Figures 6-10 and 6-11). These tanks may be formed and poured in place, or a precast septic tank may be purchased and slightly modified. This system allows the water to continuously pass through but retains the oil. The oil retained in the tank must be pumped into a tank truck and disposed. The oil separator tank principle also may be applied to above-grade diked basins if freezing temperatures are not prevalent.

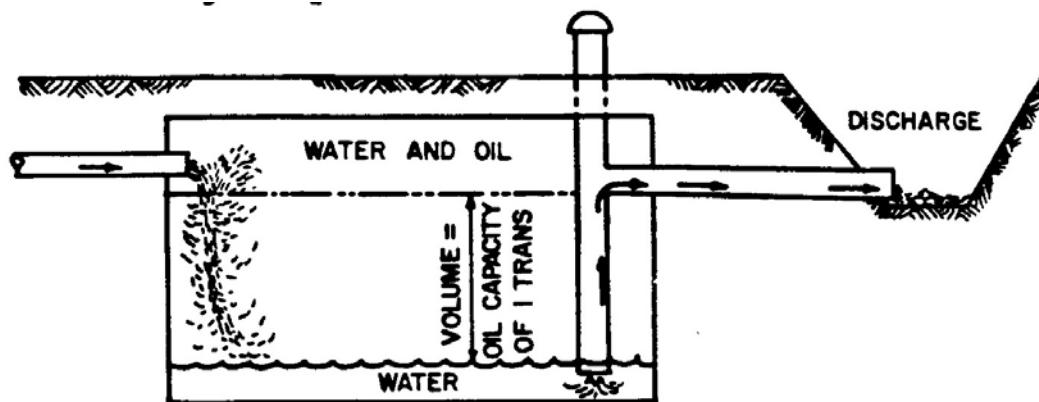

Figure 6-10: Typical Construction of Oil Separator Tank

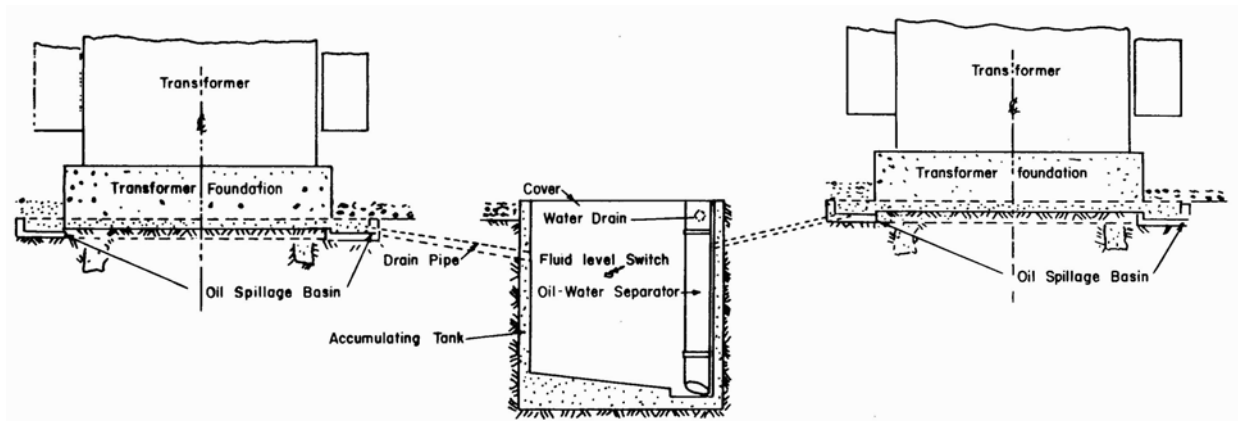

Figure 6-11: Transformer--Accumulating Tank Combination

To avoid improper operation of this system, it is necessary that the water level not be allowed to drop below the bottom of the discharge pipe inlet in the tank. All oil separator discharge pipes should be vented in order to maintain atmospheric pressure in the tank, thereby preventing any possible siphon effects.

Modification of the above-grade separator system may be considered if regular inspection is performed. It could consist of a transformer area that is lined and dike with impervious material.

a. Advantages

- Reliable
- Easily maintained

b. Disadvantages

- Relatively expensive
- Requires periodic maintenance
- Discharge pipe outlet may be inoperative during freezing temperatures

6.8 OIL STOP VALVE

The previously described oil separator tank system can be slightly modified by the use of oil stop valves to greatly improve the system's reliability.

The valve's only moving part, a ballasted float, has a specific gravity between that of oil and water. When oil spill conditions occur, the float loses buoyancy, sinking in the higher level of oil until it seats itself on the orifice to the discharge outlet.

As the spill conditions are corrected, the float rises and water is allowed to pass through the orifice. If the oily water includes neutral buoyancy material—such as suspended particles—that might interfere with the seating of the float, screening may be installed (Figure 6-12).

a. Advantages

- Smaller catch basins are required since oil can be maintained on property
- Relatively inexpensive
- Direct acting

b. Disadvantages

- Possible clogging
- Periodic inspections required

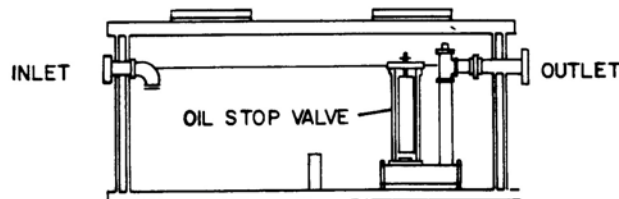
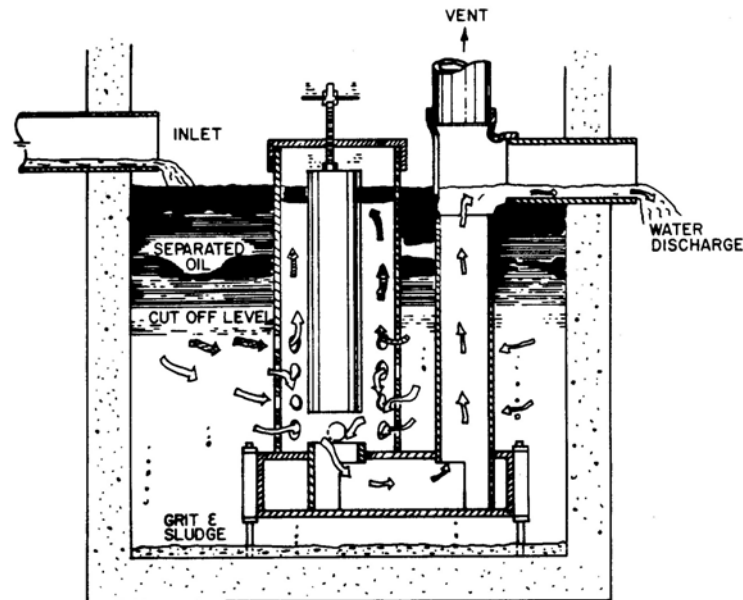

Figure 6-12: Oil Stop Valve Installation

6.9 GRAVEL-FILLED EQUIPMENT PITS

This method of oil retention provides a total means of oil containment. Refer to Figures 6-13, 6-14, and 6-15. The size of the pit surrounding each piece of equipment must be sufficient to contain the spilled oil in the air voids between the aggregate of gravel fill or stone. The pit should be lined with compacted clay, concrete, or a liner. A gravel gradation with a nominal size of three-quarter-inch to two-inch, which results in a void volume between 40 percent and 45

percent of the pit volume should be used. A more accurate value of the void volume may be obtained from the stone supplier or by estimating the specific gravity of the solid and density of the material and using the formula:

$$\text{Void Volume (porosity), \%} = 1 - \frac{\partial}{62.4 G_{SP}} \times 100$$

where G_{SP} = specific gravity of the solids
(varies from 2.6 to 2.8)

∂ = dry density of gravel fill, pounds
per cubic foot (varies from 80 to 110)

For some limestone and sandstone, the G_{SP} and values may be lower. The theoretical maximum amount of oil that can be contained in 1 cubic foot or yard of stone is given by the following formula:

$$\text{Oil, volume, gallons} = \frac{\text{void volume, \%}}{100} \times 0.1337 \text{ cu. ft.}$$

where 1 gallon = 0.1337 cu. ft.

In the case of the three-quarter-inch gravel, the estimated volume of gravel needed for a 40 percent void volume of stone to contain the oil from a 1,000-gallon transformer is:

$$\frac{40}{100 \times 0.1337} = 3.0 \text{ gallons/cu ft}$$

and

$$\frac{1,000 \text{ gallons}}{3.0} = 334 \text{ cu. ft. of gravel fill}$$

This indicates that approximately 12.4 cubic yards of gravel fill is required in order to properly contain the entire volume of oil contained in a 1,000-gallon transformer.

If pits are not automatically drained of rainwater (see Section 6.10, Oil Containment Pits), an additional allowance must be made for precipitation. The additional space required will depend on the precipitation for that area and the frequency at which the facility is periodically inspected. It is generally recommended that the pits have sufficient space to contain the amount of rainfall for this period plus a 20 percent safety margin. Appendix B should be consulted to determine the normal precipitation for any particular area.

For instance, if the Galveston, Texas, transformer facility above is to be inspected monthly, and if the overall dimensions of the pit and transformer foundation are not to exceed 12 feet by 10 feet, the additional precipitation allowance can be calculated as follows:

Maximum monthly precipitation (Appendix B, Page B-10) = 5.76 in.

Volume of precipitation = 144 x 120 x 5.76 = 99,533 cu. in.

$$\begin{aligned} \text{Vol. of precipitation plus heavy rain allowance} &= 99533 \times 1.20 \\ &= 119,439 \text{ cu. in.} \\ &= 69.1 \text{ cu. ft.} \end{aligned}$$

The volume of stone needed to contain 69.1 cubic feet of water assuming 40 percent void volume is:

$$\frac{69.1}{0.4} = 172.8 \text{ cu. ft.} = 6.4 \text{ cu. yd. of stone}$$

Therefore, the approximate volume of stone needed to contain 1,000 gallons of transformer oil in a manual drain pit is 18.8 cu. yards (12.4 + 6.4).

The area directly surrounding the pit must be graded to slope away from the pit to avoid filling the pit with water in times of rain.

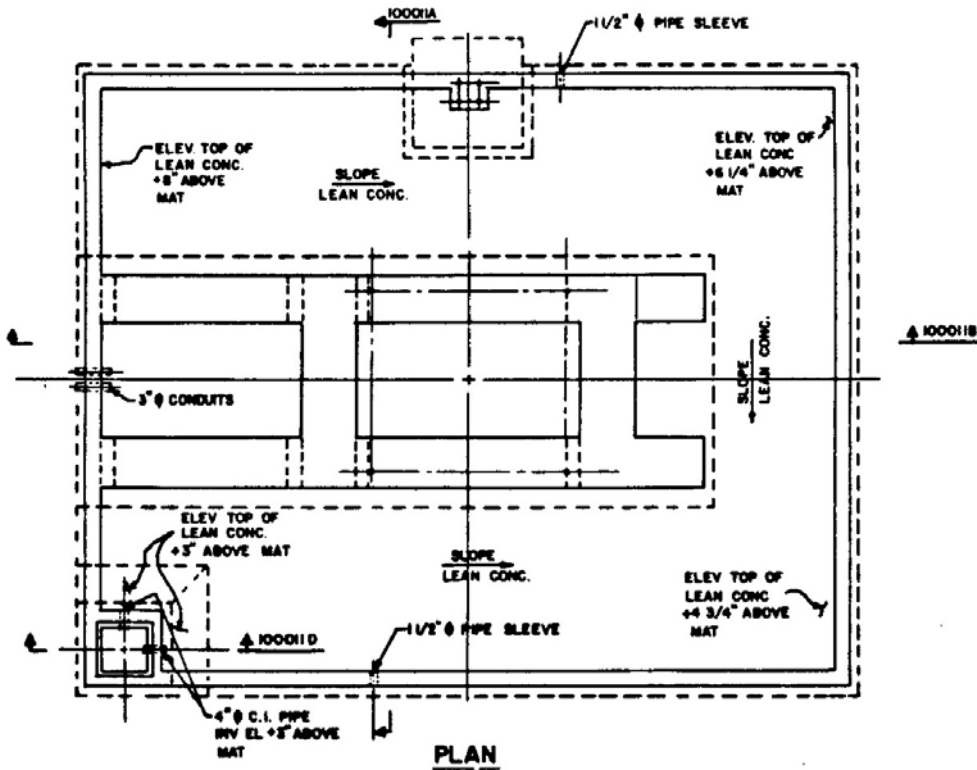

Figure 6-13: Plan View of Equipment Pit

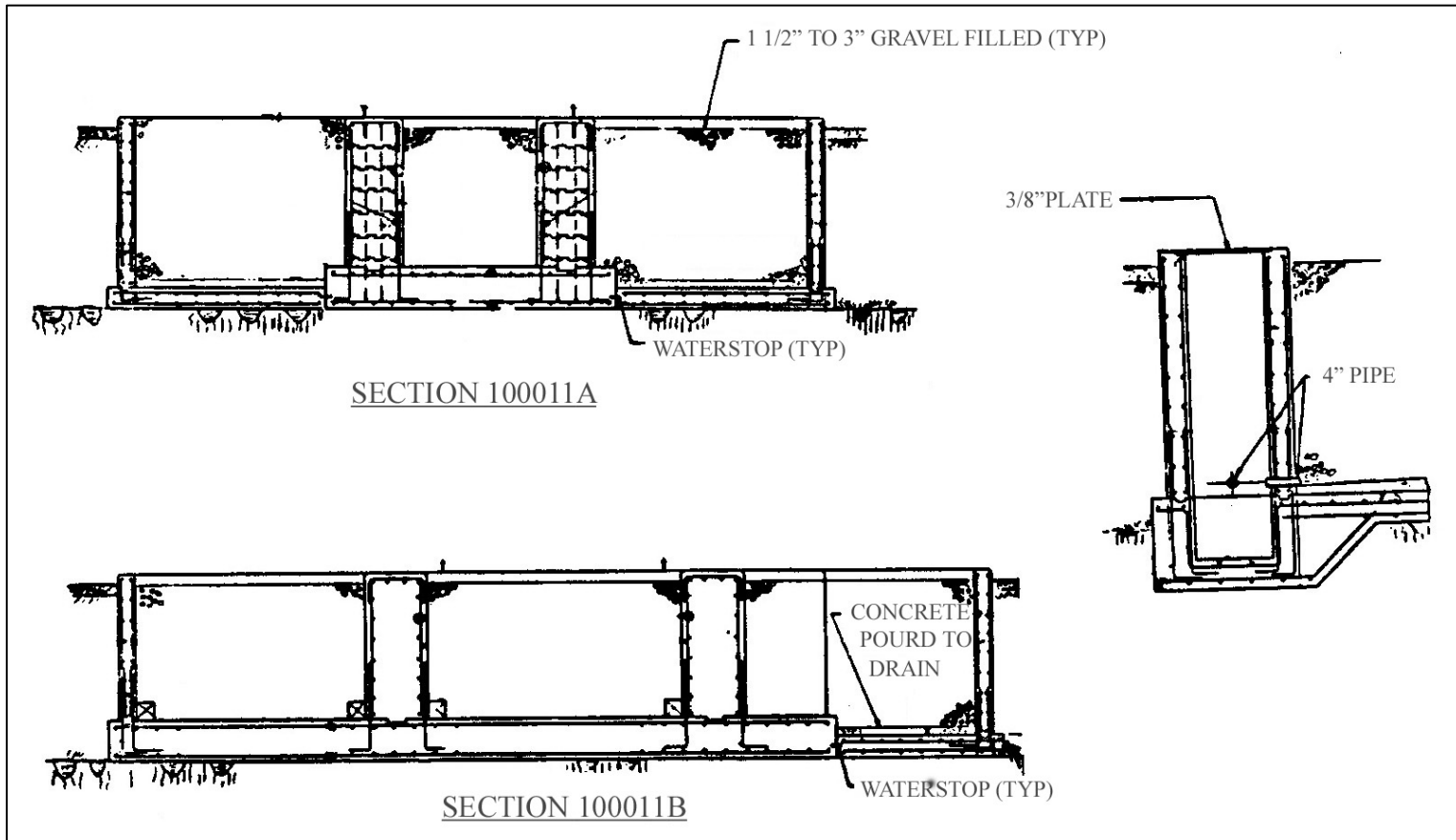
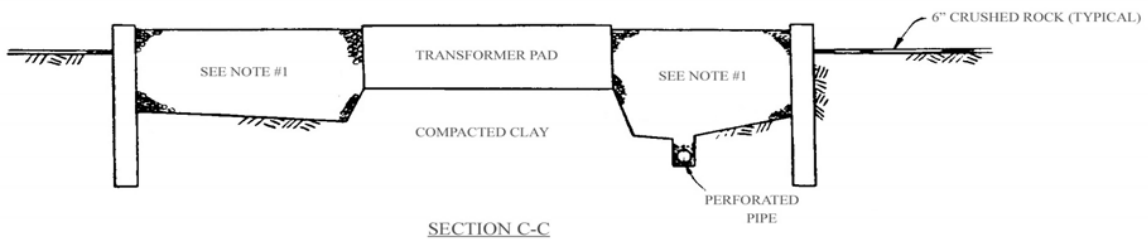
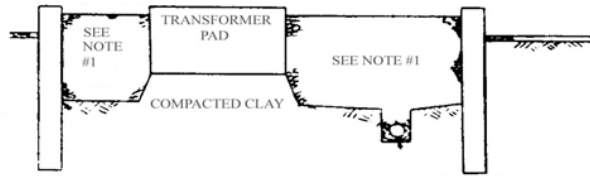
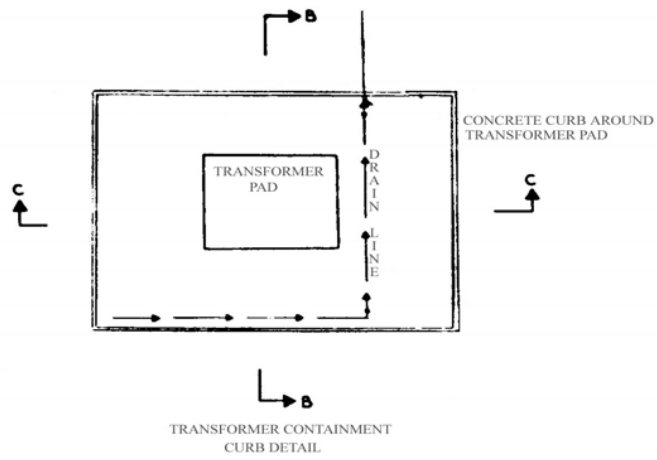

Figure 6-14: Details of Equipment Pit



NOTE 1) UNCOMPACTED UNIFORM 3/4" ROCK

Figure 6-15: Typical Drain Pit

6.10 OIL CONTAINMENT PITS

A common and reliable method of preventing spills and ensuring that oil will be contained on the substation property is to place all major substation equipment on or in concrete containment pits. These pits will confine spilled oil to relatively small areas, which in most cases will greatly reduce the cleanup costs. Figure 6-16 illustrates one method of pit construction that allows the equipment to be installed at grade level.

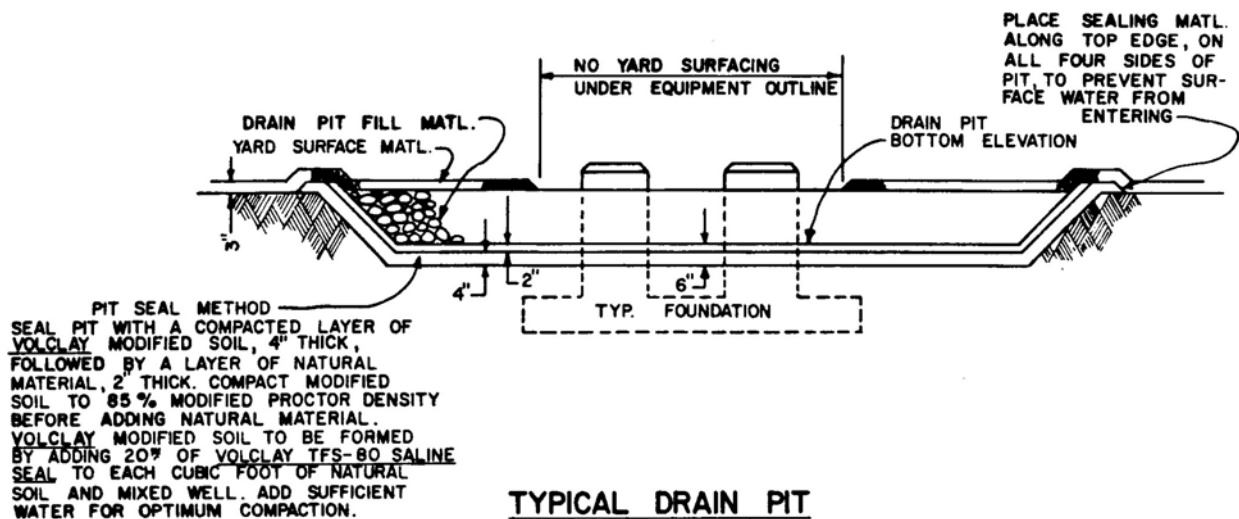

Figure 6-16: Oil Containment Pit

Berms or dikes as shown in Figures 6-17 and 6-18 have maintenance disadvantages but can be constructed relatively easily after the equipment is in place at new and existing electrical facilities.

a. Advantages

- Limit possible damage to adjacent equipment
- Minimize cleanup costs
- Require minimum amount of land
- Below-grade pits provide noise abatement

b. Disadvantages

- Expensive
- Require periodic maintenance
- Require energy to operate
- May require higher adjacent conductor supporting structure to maintain electrical vertical clearances

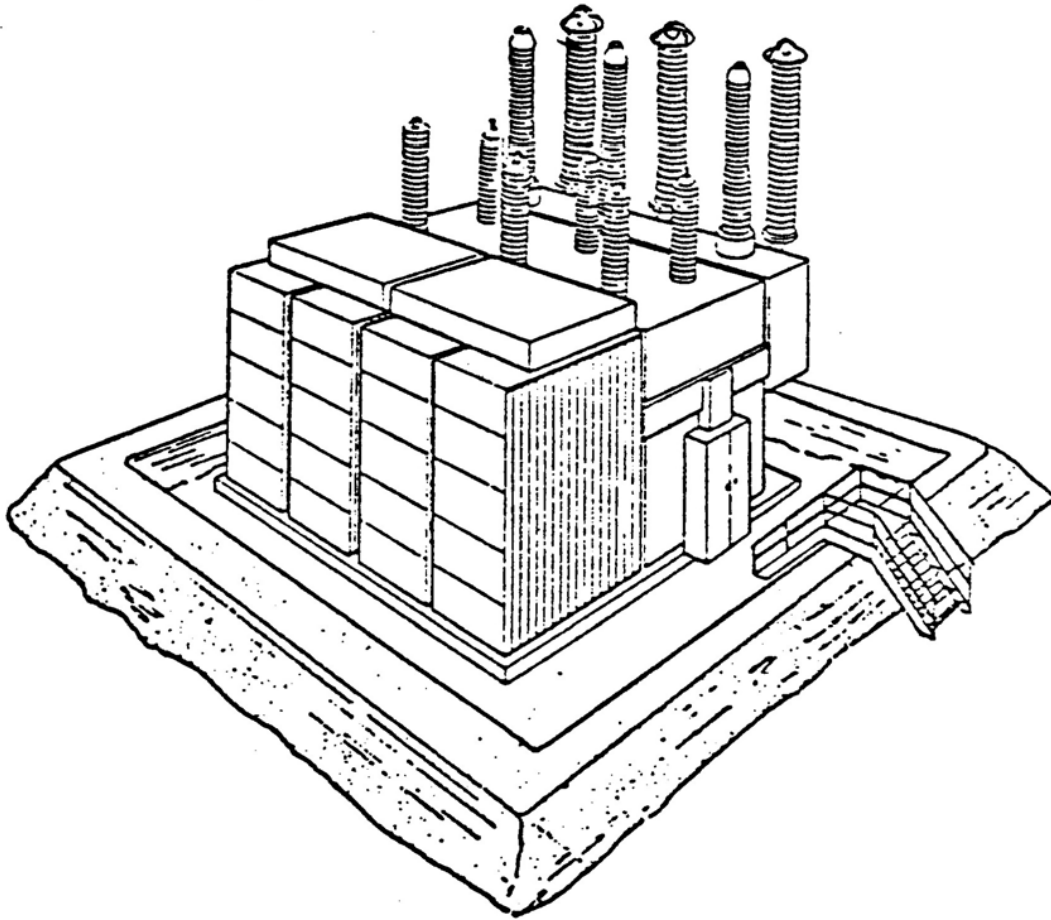

Figure 6-17: Transformer Dike

NOTE: Dike dimensions may vary as physical requirements restrict size of sponge area

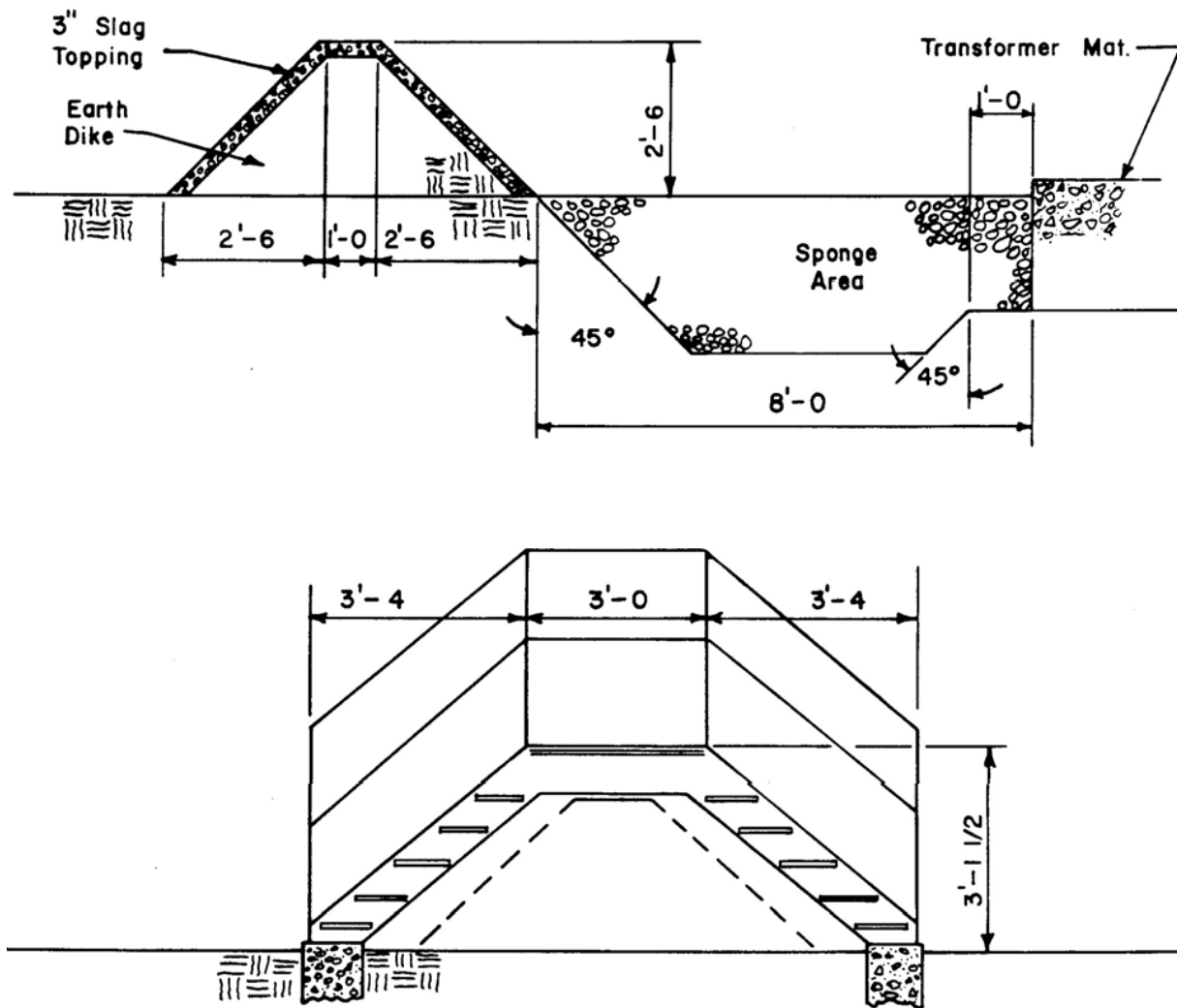

Figure 6-18: Dike, Sponge Area, and Stile Details

6.11 SUMP PUMPS

The sump pump can be manually operated during periods of heavy rain or it can be automatically operated. If automatic operation is preferred, special precautions must be taken to ensure that oil is not pumped from the pits. This can be accomplished with either an oil-sensing probe (Figures 6-19 and 6-20) or by having all major equipment provided with oil limit switches—an option available from equipment suppliers. These limit switches are located just below the minimum top oil line in the equipment and will open when the oil level drops below this point.

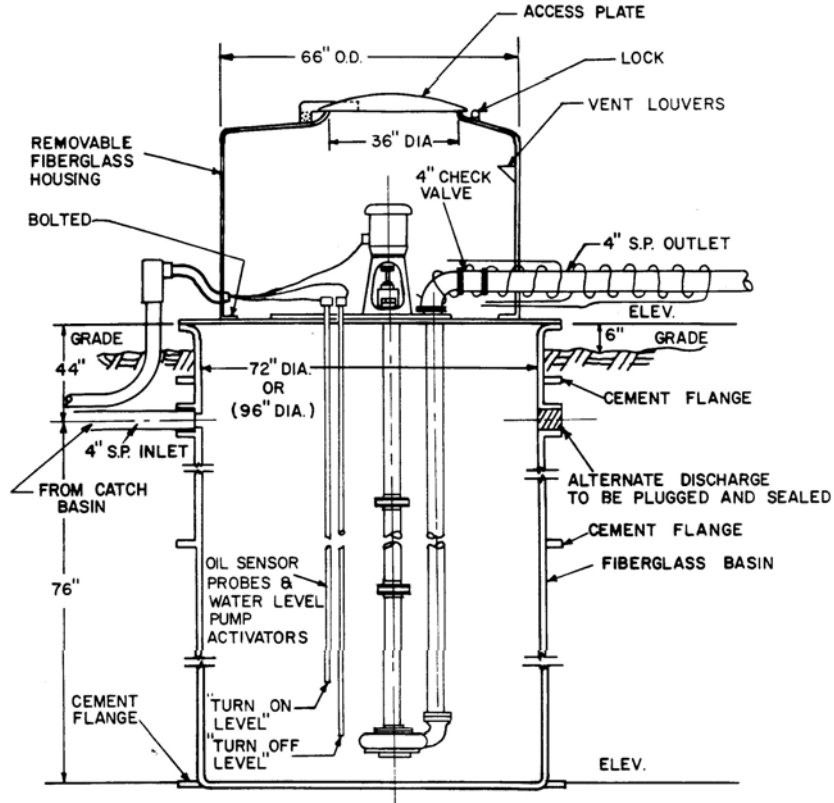
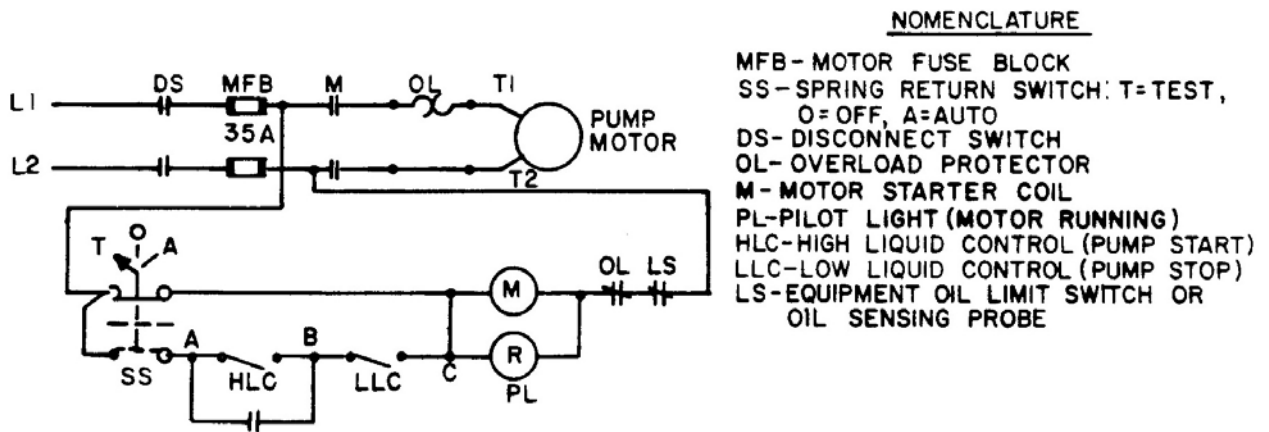

Figure 6-19: Above-Grade Sump Pump Discharge



NOMENCLATURE

- MFB- MOTOR FUSE BLOCK
- SS- SPRING RETURN SWITCH: T= TEST, O= OFF, A=AUTO
- DS- DISCONNECT SWITCH
- OL- OVERLOAD PROTECTOR
- M- MOTOR STARTER COIL
- PL- PILOT LIGHT (MOTOR RUNNING)
- HLC- HIGH LIQUID CONTROL (PUMP START)
- LLC- LOW LIQUID CONTROL (PUMP STOP)
- LS- EQUIPMENT OIL LIMIT SWITCH OR OIL SENSING PROBE

SCHEMATIC DIAGRAM

Figure 6-20: Schematic Diagram of Sump Pump Control Using Equipment Oil Limit Switch or Oil Sensing Probe

6.12 GATE VALVES

Pits may be emptied manually by gate valves depending on the facility terrain and layout, or automatically implemented by the use of equipment oil limit switches and DC-operated valves. The DC valve operation (Figure 6-21) allows surface water to normally run from the pit and closes when the oil level drops within the protected device.

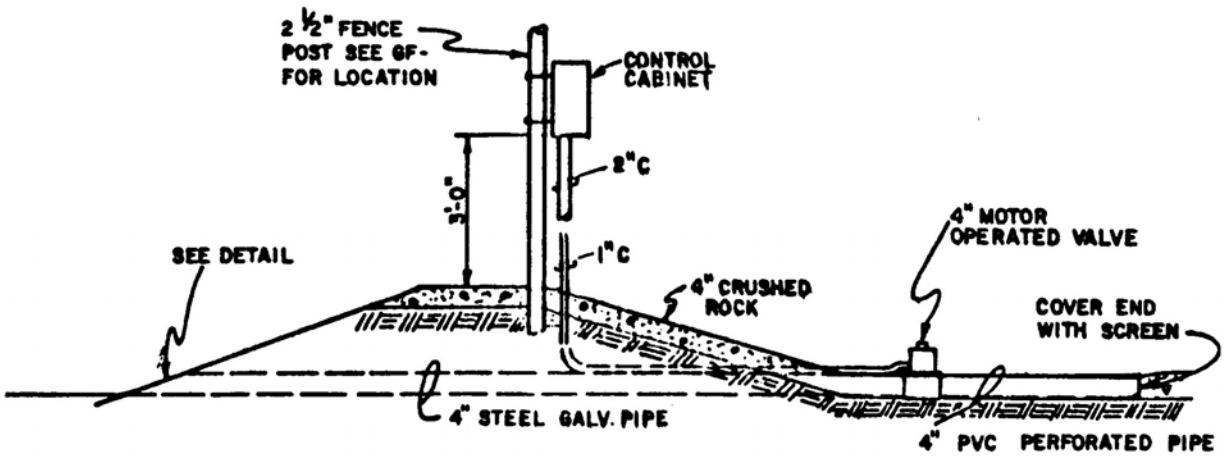

Figure 6-21: Motor-Operated Gate Valve

CHAPTER 7

OIL CONTAINMENT IN NAVIGABLE WATERS

This chapter is for oil containment after it reaches navigable water. New regulation does not change or address this issue.

7.1 GENERAL

Containment is perhaps the most important act in the removal of an oil spill, as it is used to prevent the spread of the oil, thus minimizing environmental damage. Successful containment is highly dependent on response time, which, in turn, depends on many variables. Some are permanent variables: geographic features that limit access to a spill, equipment design and availability limitations, and personnel capability. Other factors affecting response time will change with each spill: time of notification, size of spill, physical and chemical properties of the spilled oil, and climatic conditions at the time of the spill.

When designing a containment system for a given area, the exposure to spills should be considered first, followed by the permanent variables mentioned above. This review should narrow the choice of equipment to that best suited to meet a particular area's limitations. To a certain extent, personnel capability can be improved, and the other spill variables can be anticipated through training in spill drills at various times of the year.

This section deals with the principal methods or systems used to contain a spill on inland or coastal waters.

7.2 BOOMS

An oil boom is a man-made unit placed on water to serve as a barrier to the movement of oil across a designated plane. Many different types, shapes, and sizes of booms are being used, and research continues to improve their use and performance. A boom basically traps floatable material at the surface while, at the same time, permitting the flow of water under the debris-formed dam. These five components, shown in Figure 7-1, should be considered when selecting a boom that is used for oil spill containment or to direct flow:

- Float
- Skirt
- Tension member
- Ballast or weighting member
- Coupling

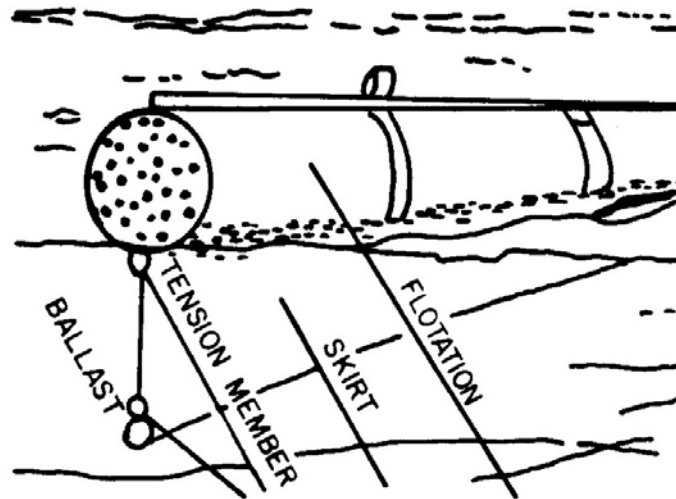

Figure 7-1: Components of a Boom

7.2.1 Floats

The principal component of all booms is a flotation device that keeps the unit afloat and, in many instances, acts as a barrier in conjunction with the skirt. Floats vary in size and shape depending on use and need. Some circular floats are as small as three inches in diameter and range upward to more than three feet in diameter. Booms are manufactured with detachable floats, air inflatable floats, or inseam floats.

The type and shape of the float are major factors in the selection of a boom, as they will determine whether the boom can or cannot be stored on a reel. Some floats will cause a storage problem because of bulk and/or the need to “accordion” the floats because of their rigidity. Another problem with some floats is their erratic behavior when deployed and towed at moderate speeds. The type and shape of float also will determine the ease of transport and recovery.

Porous floats will absorb a medium- to lightweight oil, making the cleaning of the boom after use more difficult. These types of floats can be protected with a vinyl cover and/or sealed by paint or another compound that can be cleaned much more readily.

For noninflatable floats, polyethylene foam is generally used as the float material.

Air or gas-inflated float booms are more durable, but more expensive than the plastic float types. The inflated type float provides maximum buoyancy and, when collapsed, is more easily handled and stored.

Although carbon dioxide gas from pressurized cylinders can be used for inflation, a more common method is the use of compressed air, requiring engine-driven compressors. Disadvantages of inflatable flotation range from possible escape of gas or air from leaks, ruptures, and/or possible poor heat seals.

Other types of boom floatation have been used but are generally associated with local improvisation and ingenuity. For example, logs have been joined together with cables to form a barrier. Booms also can be built from sealed metal drums joined to plywood sheets using steel cables. These booms tend to be very awkward to handle and deploy, and are not generally recommended except during emergencies.

7.2.2 Skirts

The primary purpose of a skirt is to serve as a dam or barrier with the float during containment. The skirt often extends above the water, becoming part of the float section, thereby sealing the section between floats. Skirt characteristics that should be considered when selecting a boom are:

- a. Fabric—Some booms have a plastic skirt, some a rubberized or neoprene-covered laminated material. Most use a vinyl-coated nylon or polyester fabric. This light fabric will permit a more collapsible skirt, while a heavy fabric will tend to stiffen the vertical plane. Usually, the heavier the fabric, the more ballast or weighting material that can be added. The fabric should always be cleaned and rinsed after each use. Storage of the boom usually requires it to be folded between floats. This bending and unbending requires a flexible material to prevent damage to the boom.
- b. Depth—The skirt acts as a fin when being towed and as a barrier when placed in position. Therefore, specifying the depth of the skirt of the part that is to be submerged is an important decision to make in selecting a boom. If the boom is to be towed great distances and at moderate speeds, a shallow skirt is more desirable. A longer or deeper skirt will contain a greater amount of floatable material. However, deeper skirts will have more pressure exerted on them by currents or tides and, therefore, will be more difficult to deploy and control. A skirt of less than six inches is considered impractical except for special uses.
- c. Tensile Strength—The horizontal tensile strength of the skirt—the ability to withstand pulling pressure—is limited, so care should be exercised not to exceed this strength unless the boom is reinforced with additional tensile strength members.
- d. Flexibility—A collapsible or flexible skirt fill permits the boom to seal off a spill in very shallow waters and across a sloping beach or shoreline. A rigid or vertical skirt will lie down and permit the spill to escape.

7.2.3. The Tension Member

This member determines the deployable length of a boom. The function of this member is to evenly distribute the horizontal load that may be imposed on it from currents and wind conditions. Dacron straps, steel cables, and chains are materials more commonly used as tensile members (Figure 7-2).

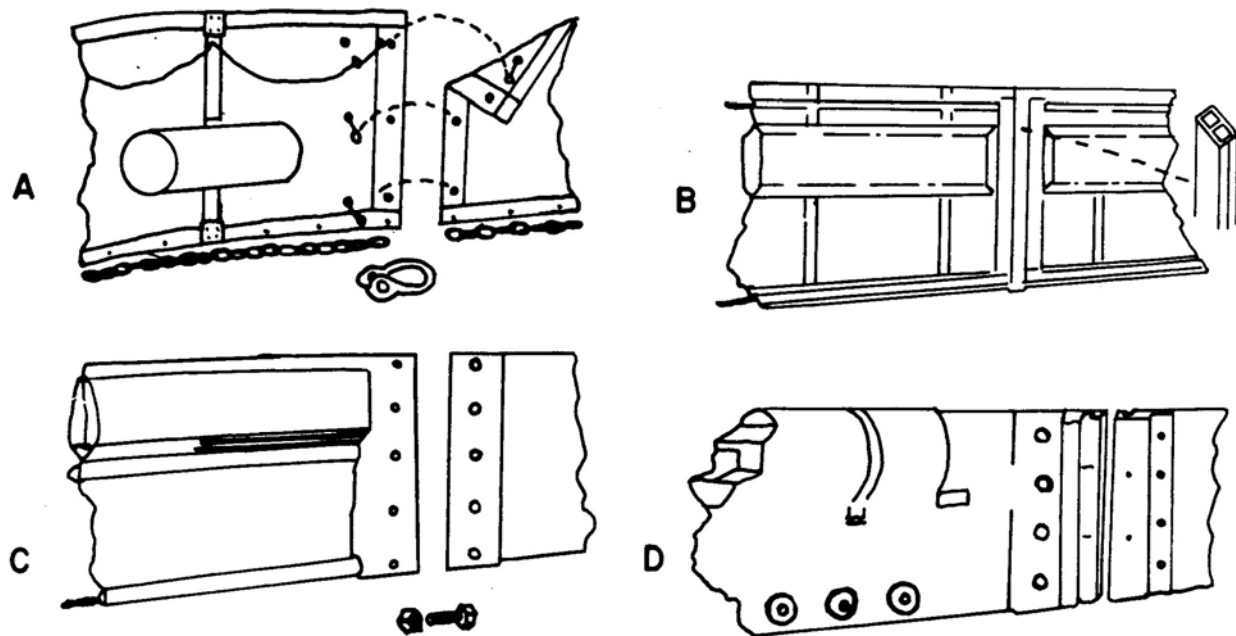

Figure 7-2: Boom Tension Members
(A) Bottom Chain, (B) Inseam Cable, (C) Dacron Straps, (D) External Cable

7.2.4 The Ballast Member

Most oil booms have a ballast or weighting member along the bottom edge of the skirt. When a boom is deployed, the ballast keeps the skirt in a more vertical position, permitting it to act as the required barrier. A more vertical skirt is more easily towed and positioned. An unweighted skirt will readily plane in very low currents. Ballast weight will vary depending on water currents where the boom is used and on how the boom is used. The deeper the skirt and the higher the current, the more ballast that will be needed.

Ballast need not be a completely fixed part of the boom, but can be attached in several ways. On some booms, ballast can be added to grommets in the skirt or to the chain or cable at the base of the skirt. In some cases, the chain or cable serves the dual purpose of ballast and tension member and, as such, it must be free for the full length of the section. Ballast should be attached to the boom with minimum looseness to prevent wear and tear of the skirt material or holding straps during handling.

7.2.5 Couplings

Booms usually can be selected in 50-foot, 100-foot, and 200-foot sections. Some air inflatable booms can be purchased in sections up to 1,600 feet long.

When shorter sections are purchased, the coupling for them should be considered. A coupling that can quickly and effectively unite two boom sections could be one of the most important factors in determining response time. Couplings that do not fit properly, or those requiring off-

site adjustments, can and will cause delays, possible leaks at the union, and in certain cases even rejection of the entire section (Figure 7-3).

Unfortunately, there is no standard boom coupling. Some manufacturers have standardized specific boom sizes and couplings so that a deployed boom may contain sections manufactured by several companies.

Nearly all couplings are rigid, extending from near the top of the float to the base of the skirt. A coupling will cause the union section to be rigid. As a result, a collapsible skirt with a coupling is not effective in waters shallower than the skirt length. Proper care of the coupling unit is essential, as a bent or corroded bolt section may require that the section be discarded.

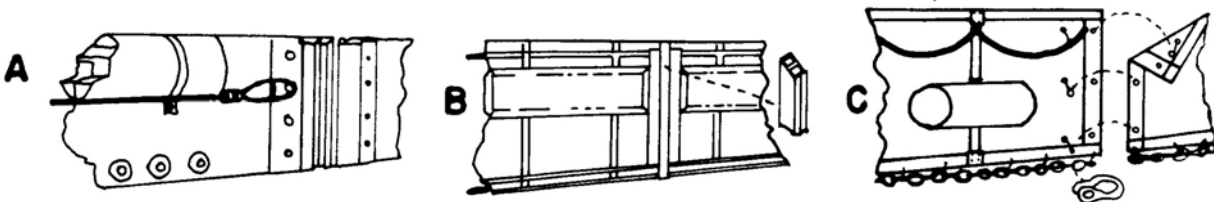

Figure 7-3: Boom Couplings
(A) Metal Interlock (Slickbar), (B) PVC Joint, (C) Bolted Overlap

The five principal components of a boom have been reviewed but these other factors should be considered when selecting a boom design.

7.2.5.1 Length: Boom manufacturers usually carry a limited number of standard sections, requiring the purchaser to specify not only the type but also the section lengths. Lengths other than standard are usually more costly. Standard lengths vary between manufacturers but are mostly in the 40-foot, 50-foot, and 100-foot range.

7.2.5.2 Factors Affecting Deployment: Deploying a boom on perfectly still water—say, on an enclosed swimming pool—is simple. However, the actual deployment of booms to serve as barriers to floating oil is more complex because of many natural variables. These variables include water pollution, current, wind, physical and chemical properties of the oil, water and air temperatures, water depth, accessibility to the spill site, source and magnitude of the spill and, finally, the type, size, and length of boom available.

7.2.5.3 Current: Floating oil will move in the same general direction and at nearly the same speed as the carrying body of water unless there are offsetting forces such as wind and/or deflecting objects in the path of the current. Any barrier, such as a boom, placed directly across the flow will be exposed to maximum forces on the skirt—that part below the surface. This load can be great enough to sever the tensile members. The current load also may exceed the vertical load applied by the ballast of the boom, resulting in “planing” of the skirt, which will release any trapped oil (Figure 7-4).

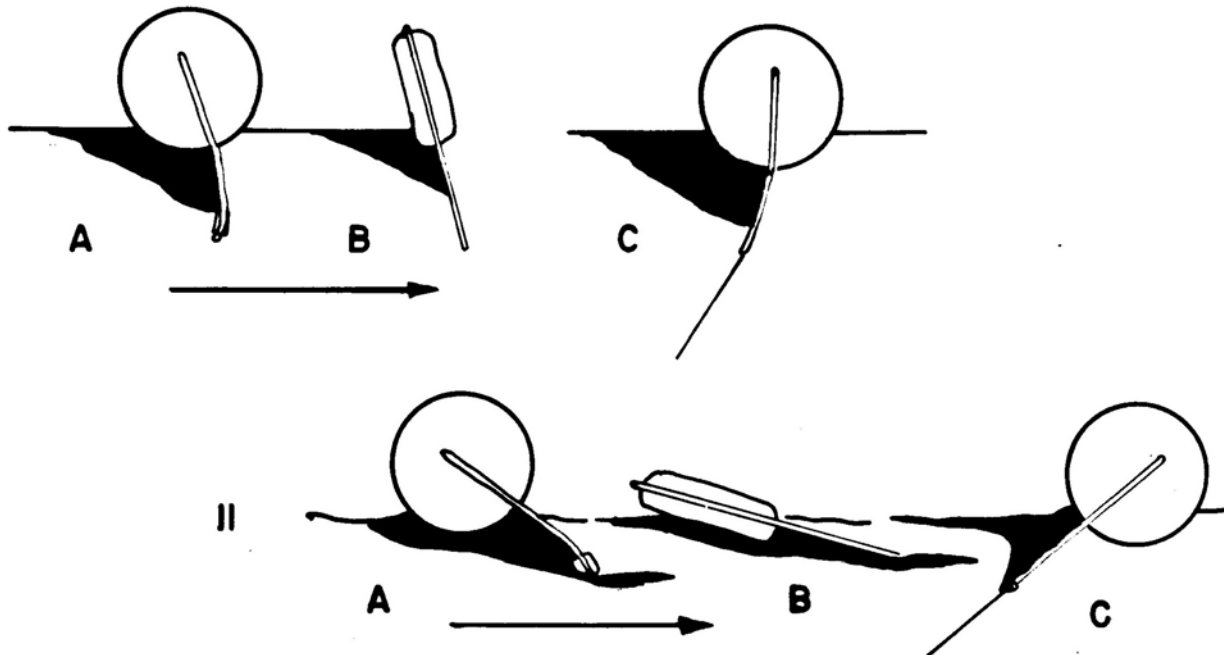

Figure 7-4: Boom "Planing" in Current

I. In low current situation, oil is held by each boom type: (A) weighted flexible skirt, (B) rigid skirt, and (C) bottom tension.

II. In high current, the flexible skirt (A) experiences partial failure, the rigid skirt, (B) is planing with current, with almost total failure, while the bottom tension (C) is still holding most of the oil. (Note: This does not consider escape by entrainment. See below).

The current forces against a deployed boom can be calculated by the following formula:

$$F = 0.92D_w V_w^2$$

where:

F = Forces, lb/lin. ft.

D_w = Depth of skirt, vertical feet into water

V_w = Velocity of water, ft./sec.

In using this formula be sure to consider:

- True depth of skirt. If the current forces are great enough to cause some planing, the true vertical depth will be less than the actual length of the skirt.
- Average water velocity. Measure the water velocity at several points near the surface and at the bottom of skirt depth and then average. These velocities can vary markedly.

Note: Winds also will affect the direction and rate of movement for oil floating on water; both forces must be considered when deploying a boom (see 7.1.5.4, Wind).

Spills in high-current waters present difficult control problems requiring specialized directional boom equipment that needs to direct the oil to the quieter waters near shore where it may be

more easily removed. Such a directional boom must be long enough to reach well out into the water, which increases the load on the boom, requiring great tensile strength. It is likely that some of the oil will escape the first boom, making deployment of a second boom in a downstream location necessary.

Many times, the currents along the banks will be deflected by submerged objects, resulting in eddy currents. This may even move water near the bank in a flow in the opposite direction of the flow in the center of the stream or channel. This reverse flow will naturally influence the trapping capability of a deployed boom.

7.2.5.4 Wind: The forces exerted by wind play a major role in oil spill containment. Factors that affect wind-moved oil on water include water current, the physical properties of the oil, and the spill size. Generally, wind will move most oil over water at a rate of 3 percent of the wind velocity. For example, with a 33-mile-per-hour wind and no current, the floating oil can be expected to move with the wind at a speed of approximately 1 mile per hour. This may not seem like much, but it amounts to 880 feet in 10 minutes. Thus, wind-driven oil requires a prompt response with a quickly deployable boom. Figure 7-5 shows some of the possible effects that wind may have on the movement of oil.

Wind also will exert a substantial force against the float or sail portion of a deployed boom. These forces should be considered when selecting a boom for deployment. They can be calculated as follows:

$$F = 0.00339V^w H^w$$

where:

F = Force exerted against float, lbs/lin. ft.

V = Wind Velocity, knots

H = Height of float above water, ft.

Winds create waves and chop, which greatly affect the efficiency of oil booms. Most booms used in coastal areas will contour well to waves where the length-to-height ratio is about 8:1. Boom performance will deteriorate as this ratio lessens. Rollover of rigid booms and submergence are common experiences when a boom is deployed in windy and choppy waters.

When wind and current are working together, the total load on a deployed boom will be the sum of the two forces. Applying the proper restraints, depending on the angles involved, can compensate for tangential forces.

A floating barrier deployed across a moving body of water to trap floating oil experiences a well-known behavior: submerged escape. A skirted boom acts much like a dam and assumes a natural catenary configuration. Floating oil will then accumulate at the turbulent base of the catenary. If the current is at or below 0.7 knots, oil will begin appearing downstream and eventually all of the trapped oil may escape.

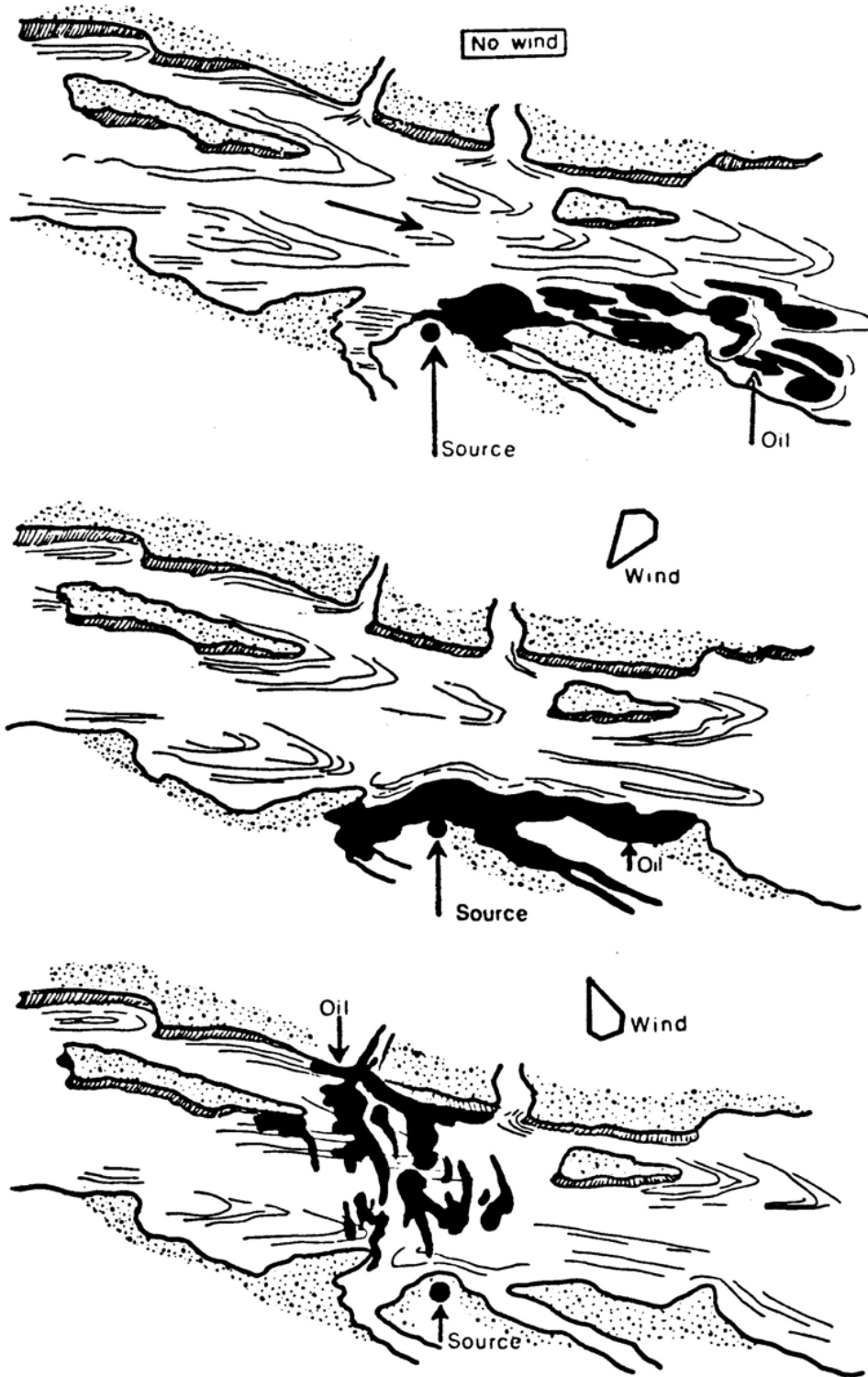

Figure 7-5: Wind Effect on Oil Movement

A deployed barrier or dam interferes with the flow of surface waters down to the depth of the boom skirt. To escape this trap, the surface water must increase its velocity and travel under the

skirt. As the velocity of the surface water increases in its downward plunge, the floating oil travels with this water under the boom. The greater the stream or tidal current, the more turbulence there is and the more trapped oil that will escape. Currents that do not exceed 0.7 knots usually do not cause oil loss under the boom. This is probably because the downward forces are not great enough to affect the gravitational differences between the water and lighter oil.

In streams, rivers, or channels with current velocities of 2 knots or more, spilled oil will usually accumulate in the quieter bends of the water channels or along the shallower and less rapid waters near the banks. This greatly aids the cleanup insofar as selecting where to deploy a boom to best trap the floating and moving oil (Figure 7-6).

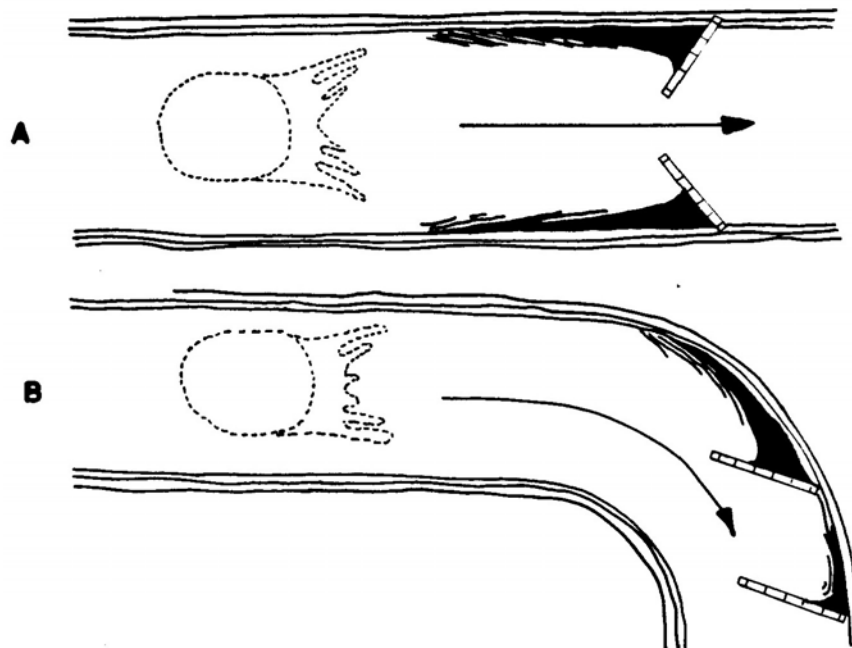

Figure 7-6: Action of Spilled Oil in Fast Current Rivers

- (A) Oil moves to lower current waters along the banks where it can be contained.**
(B) In river bends, oil will move toward outside radius bank, allowing containment.

A wind-moved oil spill will finger disperse more readily than a current-moved spill. The wind will tend to push only the surface of the oil spill and not the entire mass, while a current will carry the entire spill along with it. Where differing oil thicknesses exist, the difference between the surface tension of the water and the oil plays a significant role in the amount of fingering.

Wind can be a valuable tool to the cleanup contractor if used properly. Its force on floating oil is usually positive, with reasonably predictable results. Using a boom to guide or direct the wind or current-moved oil to a pickup center is most effective, quick, and inexpensive. However, crosswind or crosscurrent deployment of boom or wind will subject a boom to maximum load forces and risks partial to total failure. On the negative side, winds can change direction and speed quickly, drastically adding to the problem of boom selection and deployment.

7.2.5.5 Water Depth: Either a rigid or collapsible skirt boom may be deployed in water that is deeper than the depth of the skirt at all times with allowance being made for tidal differences. However, if one end of a boom needs to be onshore, near shore, or where the skirt will be exposed during low tide, a boom with a collapsible skirt should be used if available. Such a skirt will collapse on the slope of the beach, maintaining a barrier at the water's edge. A rigid skirt will fall flat and permit the trapped oil to escape unless a trench is dug into the beach or bank deep enough to bury part of the boom and keep the oil from escaping (Figure 7-7).

Deep water can cause problems in anchoring a deployed boom. Properly securing a boom deployed in deep water—more than 40 feet—requires the use of large anchors, with long lengths of rope. These extra requirements increase equipment needs and response time (Figure 7-8).

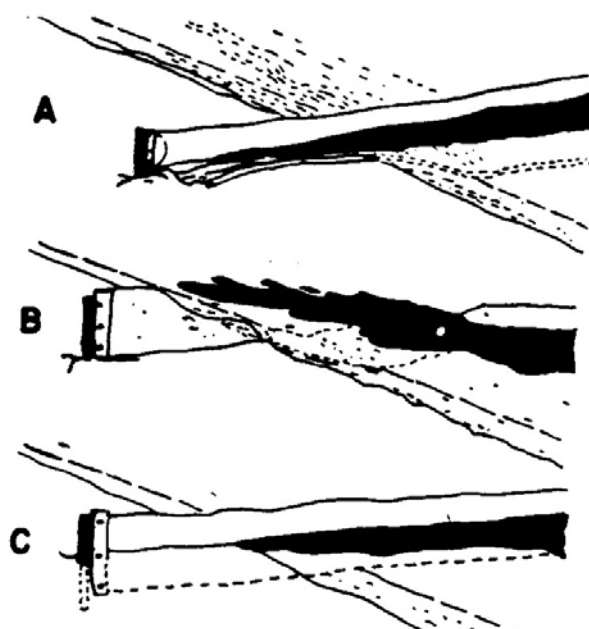

Figure 7-7: Flexible vs. Rigid Skirts

(A) A flexible boom skirt will collapse on the beach slope, trapping the spill. (B) A rigid-skirt boom will fall over, allowing the oil to escape. (C) When a rigid-skirt boom is put into a trench, it can remain vertical and trap the spill.

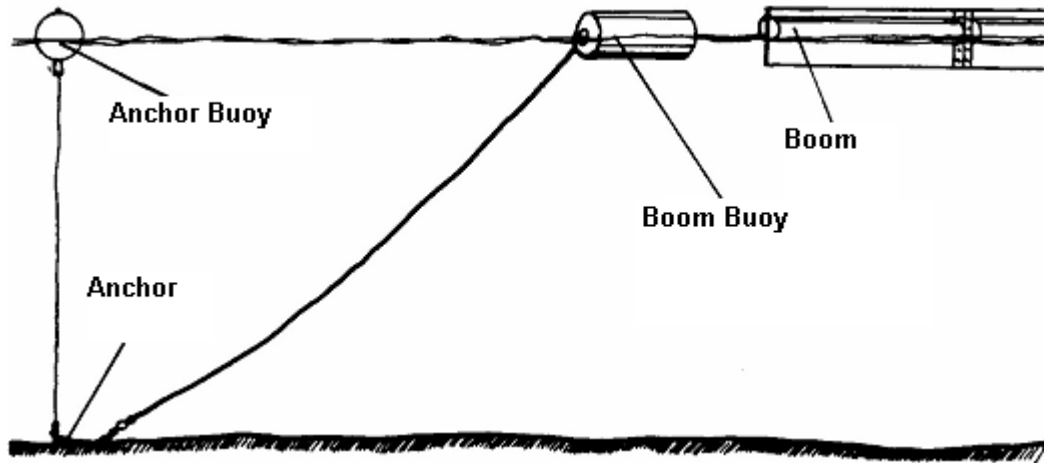

Figure 7-8: Anchoring a Boom in Deep Water (Not to scale)

The length of the line from the boom buoy to the anchor should be at least five times the depth of the water.

7.2.5.6 Accessibility and Response Time: The ideal oil spill incident for the cleanup contractor is the one reacted to soon enough to contain the source and prevent spreading. This, of course, requires prompt notification and response. Not many incidents fall into this category.

Usually the call for service is delayed because of darkness, inclement weather, or dependence on practices "as usual." A 30-mile-per-hour wind can move the spill a distance of 1 mile in 1 hour. Delays in response often are the single most serious cause for any impact an oil spill may have on the environment.

During free movement on water, oil may find its way into more inaccessible areas, where cleanup is more difficult. Controlling the oil with booms during its movement can prevent this by directing the spill to better recovery areas.

A pipe-type cable break will present a major problem, as this source is not easily accessible and the spill will continue until the pumping has been stopped and the line has lost its oil. This type of spill can occur anywhere along a cable right-of-way and may not be detected until a pressure drop is evident or the actual spill has been reported. Pipe-type cable spills can be entirely land-locked, near lakes, creeks, or rivers or in the bays and estuaries of a coastal region. A diversity of boom types, lengths, and sizes is needed to cope with these possibilities. Boom selection for this purpose will depend on exposure.

7.2.5.7 Boom Application: There are two primary methods of developing a boom: stationary, with the boom anchored or held in place; and moving, with the boom moved over the water's surface by vessels or, in certain cases, by wind forces.

The vast majority of spill situations will call for a stationary boom deployment. In certain situations, a moving deployment can provide quicker and easier recovery of spilled oil. However, moving deployment generally requires much more experience in boom and boat handling than stationary deployment. Also, it can more easily end in the loss of trapped oil if diligence and care

are not taken during all phases of the operation. In stationary deployment, wind and current act to destroy the effectiveness of the boom. As noted earlier, high winds or currents of 0.7 knots or more will carry oil under a conventional boom. With low current and/or wind velocities, boom deployment directly across, or perpendicular to, the flow will contain the spill.

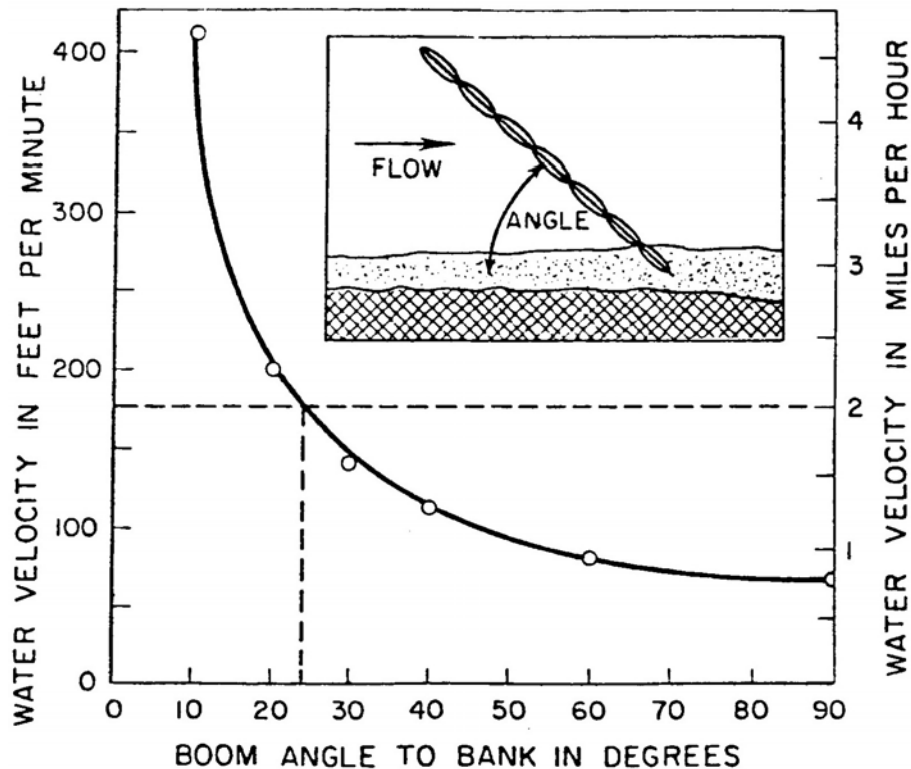

Figure 7-9: Suggested Boom-to-Shoreline Angles for Different Current Velocities

With a current of about 0.85 mph, the angle can be 60°. A current of 1.5 mph requires a 30° angle. A current of 2.75 mph can be handled with a 15° angle. When stream current velocity exceeds 3 mph, seek out bends or other places where the current naturally slows down to a more reasonable speed.

To cope with those situations involving water velocities above the magic 0.7 knots, booms can be deployed at an angle to the flow. This type of deployment will reduce the force against the boom and direct the oil along the side of the boom to a collection point, usually the shoreline, but often a floating skimming device.

The smaller the angle between the collection point and the boom, the greater the current toleration. See Figure 7-9.

When a boom is used as a directional device, anchoring along its length should be avoided whenever possible. Figure 7-10 illustrates some of the problems that can arise in such a situation.

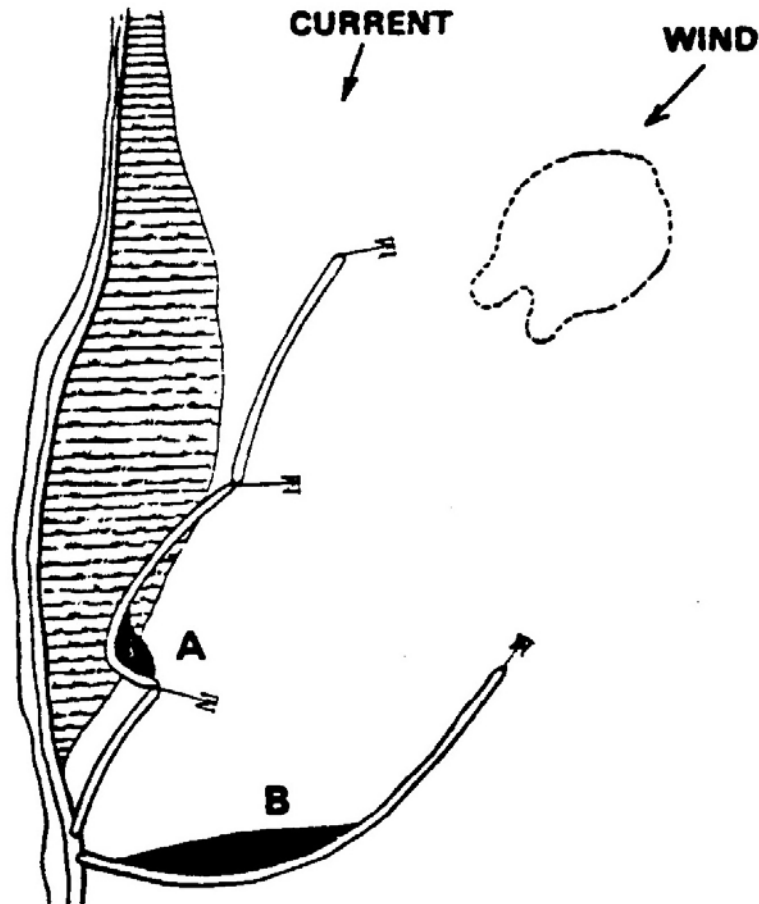

Figure 7-10: Possible Problems Caused by Improper Boom Anchoring

- (A) If a deflection boom is allowed to form a deep catenary configuration between anchoring points, some of the oil will remain trapped in these pockets.
- (B) If a containment boom is allowed to form a catenary, the oil will collect in the catenary, rather than move to the shore. In either case, recovery of the oil is much more difficult.

7.2.5.8 Moving Deployment: When the body of water is wide enough or the oil is moving near the center of a stream, deploying a boom directly across the path of the spill can contain it (Figure 7-11). The boom should be controlled at each end by a vessel that can easily maneuver in the particular waters. The boom should be allowed to form a deep catenary configuration to trap the oil at the base of the catenary. As the oil reaches the boom, the entire trap and vessels should move downstream—downwind—at near the speed of the current (wind) holding the spilled oil within the catenary arc. Care should be taken not to pull one end against a current, as this will cause the skirt of the boom to plane, releasing the trapped oil.

At an opportune time and place, one end of the boom can be moved ahead, carefully maneuvered toward the shoreline and tied. Meanwhile, the other end can be moved somewhat upstream (upwind) from the tied-down end. The oil then is allowed to slide downstream (downwind) along

the side of the boom to where it will concentrate and can be removed. A successful operation of this type needs practice and expert boat maneuvering.

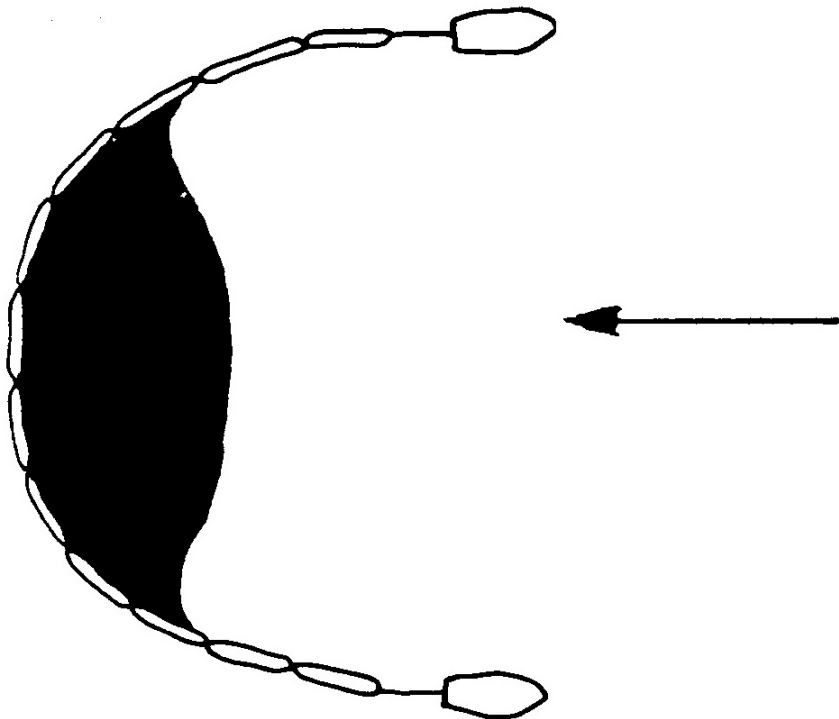

Figure 7-11: Moving Deployment

A boom is held in a catenary between two boats, which move downwind (down current) at or near the speed of the wind (current)

7.2.6 Special Situations

Debris often accompanies floating oil, particularly in streams and rivers, but to some extent in all watercourses. This debris can cause removal problems by clogging most recovery devices and/or by absorbing the oil. Large pieces or great amounts of debris can pile up behind a boom, raising the skirt enough to allow the trapped oil to escape, damaging the boom or even breaking it.

When containing a spill in a high debris location, special precautions have to be taken. Double or even triple booming may be necessary. Alternately, a debris “fence” could be deployed upstream of the containment boom, with a crew stationed to clean off the debris as it piles up.

Since the deployment of a boom is controlled primarily by the direction and speed of current and/or winds, rapidly changing winds or currents—such as ebb and flood tides—will create difficulties in keeping the spilled oil contained.

Knowledge of the behavior of the changing currents and winds peculiar to a specific area is paramount in determining how and where to deploy containment booms. This knowledge can be gained from local experts through trial runs and maintained with periodic drills. To ensure

containment, more than one length of boom will need to be deployed. Figure 7-12 illustrates one method to use or consider in such a situation.

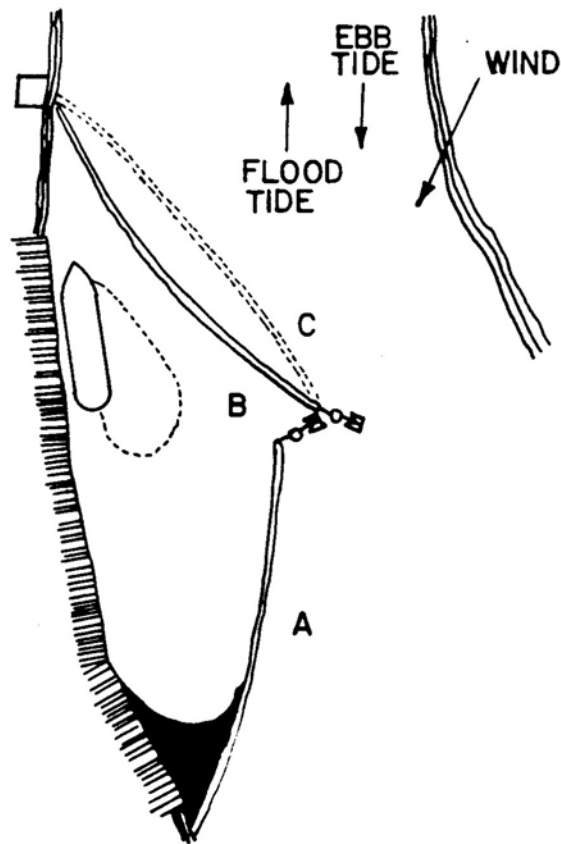

Figure 7-12: Changing Currents

If a spill occurs during ebb tide, with a prevailing wind as shown, the primary containment boom would be deployed at A. A secondary boom would be deployed at B to maintain containment during flood tide. (Note: During flood tide, the secondary boom would assume the shape shown by dotted line at C.)

7.3 CONTAINMENT DAMS

Although the deployment of floating booms is by far the most-used oil spill containment method, other types of containment will be more effective and easier or cheaper to accomplish at other locations and in different situations. Streams, creeks, and other small drainage channels—usually in inland areas—are often too narrow, too fast-moving, and/or too steep-sided for proper boom deployment. For spills on these types of waterways, containment dams constructed from either earth or absorbent materials offer a good choice for trapping the oil.

7.3.1 Earthen Dams

An earthen dam can be constructed quickly across a dry creek bed using a bulldozer, dragline, or backhoe. If necessary, a crew of workers can build the dam with shovels, but this method is not

recommended except in extreme emergencies. In any event, lead time—the amount of time before the spill is expected to get to the containment site—is critical. When selecting a dam site, it is necessary to choose a location far enough downstream to be able to finish the dam before the oil arrives.

In constructing the dam, place two or more drainpipes or culverts near the base, positioned in the direction of the stream flow. These pipes need to be longer than the width of the dam at its base, and should have a diameter large enough to allow passage of the water without causing it to back up higher than the dam. Multiple drainpipes are used to control the water flow. By plugging one or more of the drainpipes, the water can be maintained at the proper level to keep the oil afloat, yet trapped behind the dam. Installing the pipes on a slant also can help control the water level (Figures 7-13 and 7-14).

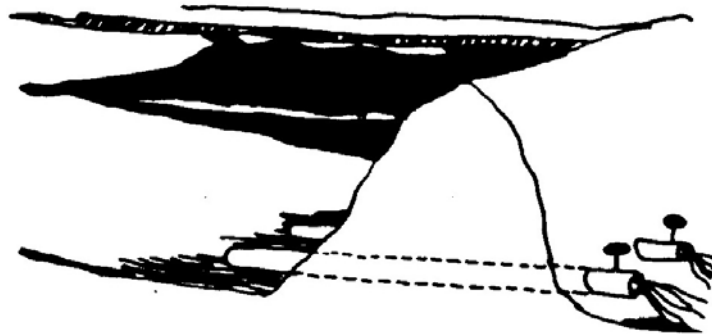

Figure 7-13: Earthen Dam, Cross Section

Multiple pipes near the bottom with valves to control the flow and retained depth of the water.

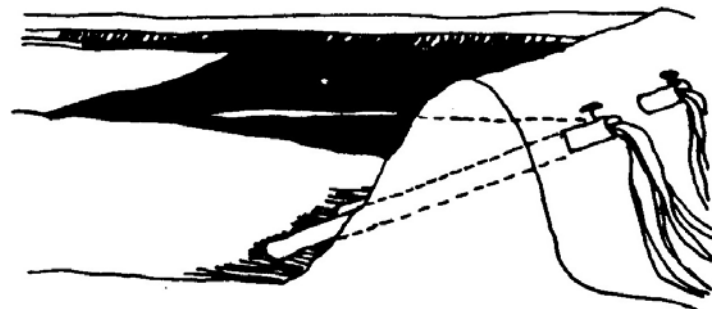

Figure 7-14: Earthen Dam, Cross Section

Pipes installed on an incline to control water depth. The top of the incline determines the height of the retained water and oil.

Once drainpipes are in place, the remainder of the dam can be built up to the desired height, being sure to keep the earthen material well compacted during construction. The final height should be just enough to trap the oil. The width across the top will depend on the need for equipment and personnel to cross the dam.

7.3.2 Straw or Sorbent Dams

Occasions will arise when floating booms or earth dams are not practical for containing a floating spill on a shallow and relatively narrow creek or streambed. In this situation, a straw or absorbent dam can be constructed.

This type of dam can be constructed readily in shallow running water from materials usually available in any community. Across a deeper body of water, hanging the barrier to a cable suspended across the stream will accomplish the containment. In the latter case, weights will be needed to keep the base of the barrier from planing downstream, releasing the absorbent and oil. (Figure 7-15).

A sorbent barrier is constructed by first stretching a wire fence across the stream and anchoring it firmly at each bank. The wire may be chicken, hog-type, or chain-link, but it should be dense enough to prevent straw or other sorbent materials from washing through it easily. The wire fence can be kept vertical by driving steel support posts or pipes into the streambed at 8- to 10-foot intervals. Once the fence is erected, straw can be scattered across the upstream side to a depth of 4 to 6 inches, extending upstream some 10 to 15 feet, depending upon the size of the spill.

Sorbents other than straw may be used; however, make sure that sufficient material is used to ensure some sorbent depth at the dam. Whereas straw readily gives a desired depth, some other sorbents tend to float permanently and additional material is needed to achieve the proper sorbent depth at the barrier.

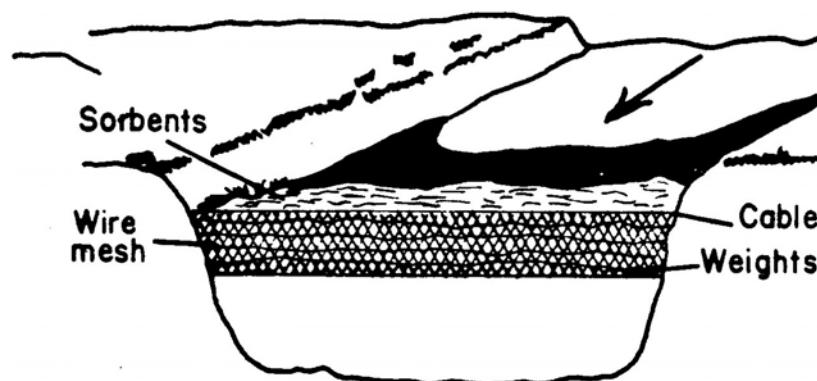

Figure 7-15 : Cross Section of a Sorbent Fence

Weights on the bottom of the wire mesh keep it from planing and releasing the sorbent and oil.

The effectiveness of this type of barrier depends on the amount of water in the stream and its velocity, size of the spill, and physical characteristics of the oil. Runoff from a large rain may well cause dam failure. Under normal conditions, a sorbent dam should withstand water

velocities of up to 2 feet to 2-1/2 feet per second. The type of oil spilled will determine how much sorbent material will be needed. The lighter the oil, the more absorbent that will be needed. Therefore, second and even third absorbent dams may be necessary to recover all the spilled oil.

7.4 COLLECTING AGENTS

Under favorable conditions, certain oil spills can be contained temporarily with chemicals. When applied to the surface, these chemicals will retard the spreading oil and may even concentrate the spill. Wind, waves, rain, and currents may hamper the use of these collecting agents and, therefore, must be considered when contemplating the use of collecting agents.

The CI Agent product, as introduced in Section 6.5.2—in loose powder form or in the form of marine booms, pads, and pillows—can be used to immediately control emergency hydrocarbon spills, to immobilize the petroleum-based material on either fresh or salt water. In loose form, CI Agent can be broadcasted manually or with mechanical assistance. Obviously, the choice of the immobilization method will depend on the nature and size of the spill, and the surrounding ambient conditions, downstream environment considerations, and disposal product reclamation options.

CI Agent can also be used in its many forms on lakes and ponds whenever the public, marine life, or other wildlife is threatened, or when the spill is heading toward flowing waters. Again, the nature and size of the spill determines the method of use. In loose form, CI Agent can be broadcast over the entire area and once the spill is solidified, holes can then be cut into the mass, so as to allow the lake or pond to breathe to save the marine life. Retrieval of the encapsulated material from the water can then take place by skimming or vacuuming.

CHAPTER 8 OIL REMOVAL MATERIALS

8.1 SORBENTS

“Sorbent” is the term given to those products or materials that are oleophilic—oil-attracting—and hydrophobic—water repellent. That is, they have a high capacity for adsorbing or absorbing an oil product, and they tend to repel water. In usable form, sorbents must float on water long enough to adequately collect the oil and then be removed.

Definitions of sorbents provided by the American Society for Testing and Materials include:

Adsorbent—An insoluble material that is coated by a liquid on its surface, including pores and capillaries, without the solid swelling more than 50 percent in excess liquid

An incomplete list of adsorbent materials used on oil releases includes plastic fibers such as polypropylene, plastic foams, straw, peat, sand, feathers, foamed glass and silicates, activated alumina, and soil.

Absorbent—A material that picks up and retains a liquid distributed throughout its molecular structure, causing the solid to swell—50 percent or more. The absorbent must be at least 70 percent insoluble in excess fluid.

Absorbent materials for organic liquid releases include rubbers and cross-linked products such as imbibing polymers.

Sorbents can be classified as either mineral products, natural (organic or agricultural) products, or manufactured (synthetic) products.

Sorbents are used widely to clean up small terrestrial or marine spills and for completing the cleanup of a large spill. Their use is generally more costly than conventional mechanical procedures except for small, or thin-layer oil spills. Sorbents usually have to be spread and recovered by hand, thus limiting the area that can be adequately cleaned by this process. Selection of sorbent materials for storage and use will be influenced by the local exposure to oil spills and the type of hydrocarbon that might be spilled. The following may assist in this selection.

8.2 MINERAL PRODUCTS

Several commercially available minerals have a high affinity for oil, including volcanic ash, diatomaceous earth, vermiculite, perlite, and some chalks. For oil spill cleanup work, these materials need to be ground into a very fine-grain form. This leaves much of the material as dust, one of its greatest disadvantages. The materials do adsorb certain oils to acceptable ratios—three to six times their weight—but are very expensive and thus are not commonly used for oil-on-water cleanup. Also, the oil spill recovery process may be complicated because these materials may:

- Be too fine-grain to permit removal by conventional means such as nets and sieves
- Be abrasive to mechanical pumps
- Require specialized equipment to spread and recover
- Not burn, eliminating burning as a disposal process.

8.2.1 Natural or Agricultural Products

Many agricultural products are available for use in adsorbing oil from water. Most leaf-like plants contain some natural oils, giving them a greater affinity for oil than water. When dry, they are lightweight enough to float on water. All of these products will become water-wet and sink, carrying the oil with them. Straws with hollow stems will float for longer periods than grass or hay. These sorbents are plentiful in agricultural communities and usually are available within a short distance.

Agricultural products are relatively inexpensive but are bulky. If needed in sizable quantities, they will require large protected storage areas. Rain-wet straw or hay loses a great deal of its affinity for oil, is more difficult to spread, and will sink more readily. The method of packaging or baling is important. Baling wire will quickly rust out in humid climates, rendering the bale useless for transport. Plastic baling line for storage of hay or straw is preferable.

Spreading an agricultural product on the water or along a beach can be a costly and time-consuming operation unless a mechanical spreader can be used. Such mechanical units usually are available in agricultural communities and also are used by highway construction contractors.

Some of the natural products that have been tested and used as oil spill sorbents include

- Rice straw
- Oat straw
- Wheat straw
- Flax straw
- Johnson grass (hay)
- Coastal Bermuda (hay)
- Bagasse (sugar cane)
- Buffel grass (hay)
- Red top cane
- Cottonseed hulls
- Corn cobs (ground or unground)
- Peat moss
- Sawdust

Straws are the most common and widely used natural sorbent materials. Straws can be oat, wheat, rice, or flax. These are available to most communities. They are the most adsorbent of the agricultural products. Straws will float for longer periods because of their hollow or fibrous stems. Straw is the least expensive of the natural products and, if baled properly, can be stored for many years. Tests have shown that straws have a 30 percent greater oil adsorbing capacity

than hays, 40 percent more than canes, and 100 percent more than cottonseed hulls. Straws have been known to adsorb between 8 times and 30 times their weight in oil.

Grass or hay makes a good sorbent. It is generally available as feed for livestock, but since it is a feed, it costs more than straw. This is principally a leafy material that has a high oil-adsorbing capacity. However, it can and will become water-wet and sink with the oil. Its use in shore-side or beach operations may be justified. It can be removed from the water with fine screens and easily raked into piles on a beach.

Bagasse and red top cane are regional products. Bagasse has a high affinity to oil but will readily become water-wet and sink. Red top cane, like bagasse, quickly becomes water-wet and sinks. Also, it has a relatively low oil sorption capability.

Peat moss is expensive for oil spill cleanup work. Like cottonseed hulls and corncobs, it will readily become water-wet and sink. These products can be used on land and on beaches but their cost may preclude their use.

Sawdust quickly becomes water-wet, reducing its oil-adsorbing capacity and it tends to sink quite readily. Sawdust is also easily churned at the beach by breakers and dispersed in the water column, adding to the problem. On the beach, sawdust readily mixes with the sand during raking, making it impossible to remove.

8.2.2 Synthetic Products

Synthetic products are widely used and are available from manufacturers under various trade names. The adsorbent types are manufactured from high molecular weight polymers such as polypropylene, which has higher adsorbing capacities than mineral and cellulosic products. Polyurethane, for example, theoretically can adsorb up to 90 percent of its volume. It may in some forms collect several times its own weight in oil—more than the mineral or cellulosic products. Adsorbents cannot sorb more than their own volume. The viscosity or thickness of the liquid being adsorbed will impact upon the adsorption capacity and the amount of oil the material will retain on its surfaces. Some of the adsorbed oil can be rereleased from the adsorbent during retrieval operations if the viscosity is insufficient to cause the oil to adhere to the material's surfaces. This may impact upon the material's overall effectiveness for certain oil recovery operations.

The absorbent type of synthetic products is also available from manufacturers. These products include cross-linked polymers and rubber materials, which absorb liquids into their solid structure, causing the sorbent material to swell. It is the swelling of the absorbent that distinguishes it from adsorbents. The capacity of absorbents is generally measured in volume/volume ratios as the swelling characteristic of absorbents allows these materials to pick up many times their volume in spilled liquid. Viscosity also will impact on the effectiveness and the absorption capacity. Temperature may impact on the absorption rate, with lower temperatures tending to significantly slow the rate. As liquids are integrated into the absorbent material, the liquid cannot be rereleased, which virtually eliminates secondary contamination of the environment and response personnel.

The performance characteristics of both absorbents and adsorbents should be considered when considering overall cost-effectiveness of a product for cleaning up oil and organic chemical spills. Oil types and their viscosities also should be considered, as well as ambient temperatures.

The adsorbent synthetic products are marketed in various forms: (1) as a relatively fine-grain, loose, and sugary textured material; (2) as a medium coarse material with particles the size of a dime or less; (3) as pads one-quarter inch to one-half inch thick and approximately 12 to 24 inches square; (4) as particulate baled in pieces the size of a fist; (5) in rolled sheets 3 feet wide and 200 feet long; (6) in various pillow-shaped forms; (7) as sorbent booms; (8) as a mop similar to a household mop; (9) as a tangled mass of thin strips; and (10) in liquid components for on-site generation of a sorbent foam that can be chopped and spread by hand or by mechanical means.

The absorbent synthetic products are marketed in pads, blankets, booms, mini-booms, rolls, and socks suitable for groundwater cleanup. One product contains the polymer beads that also are used in oil stop drain valves described in Chapter 6. Another product that functions mostly like an absorbent product actually chemically reacts with oil to form a rubber type compound. It may be an effective alternative in colder weather as absorption time is less affected.

8.2.3 Chemically Modified Natural Product

There is a chemically modified cottonseed lint absorbent. It can sorb two to six times its weight, depending on the product. It is at least five times as effective as calcined clay—cat litter—for mineral oil. In addition, the product has nutrients to encourage the growth of microbes to “eat” the oil. Studies show that, with proper application, this product can bioremediate an area within 120 days.

8.2.4 Other Products

Other marketed forms will undoubtedly be developed as the need arises, technology advances, and research is performed.

8.3 WHEN AND HOW TO USE SORBENTS

The use of sorbents for oil spill cleanup work varies in different areas of the country. Some cleanup contractors limit their stockpile to synthetics, while others include agricultural products—principally straw.

The following characteristics of sorbents will influence their selection and use:

- Sorption Rate—refers to the speed of absorption or adsorption. The rate of sorption will vary with the thickness, or viscosity, of the oil.
 - Adsorbent materials are generally more effective with more viscous liquids. The thicker oils tend to adhere to the surface of the adsorbent more effectively. While adsorbents are generally very fast at adsorbing lighter oils, they also will tend to

rerelease an amount of these lighter oils just as quickly on retrieval, causing secondary contamination.

- The absorption mechanism requires liquids to diffuse into the solid structure of the absorbent material. The absorption process is generally faster with lighter oil products and slower with heavier oils. Once absorbed, these liquids cannot be rereleased. Absorbents are very effective with light hydrocarbons such as gasoline, diesel fuel, and benzene, which tend to create problems for adsorbents.
- Oil Retention—Adsorbents will release varying amounts of oil and organic liquids, depending on the viscosity of the liquid, during retrieval operations. This is because the liquids are held on surfaces either within the adsorbent material, such as pores, capillaries or interstices, or on external surfaces of plastic fibers or mineral granules. In a stream current in excess of two knots, some oil adhering to adsorbent materials will be stripped off by flowing water.

Conversely, the retention of oil by absorbents is absolute. Because the oil has become an integral part of the absorbent material's structure, and not on a surface, the oil cannot be removed by stream currents, compression, or gravity.

- All sorbents are bulky; storage of sizeable quantities requires larger, covered storage facilities. Straws or agricultural products are the bulkiest and require special storage to prevent rodents from nesting and ruining the sorbent.
- In heavy oil exposure areas, stockpiling of sorbents is a must. Having to wait on delivery of sorbents may be the difference between a minor disaster and a major disaster.
- Sorbent products are available in various shapes and sizes. Straw or agricultural products come in bales, spread by a mechanical mulcher. Synthetics are available in many forms, from sugary granules in bulk to blanket sheets. They are usually spread by hand, but mechanical spreading is available for those products made available in a particulate form.
- On a per-pound basis, straws are much cheaper to purchase than the synthetics. For synthetics, greater sorption ability, the ability of the absorbent type of synthetics to permanently retain the absorbed oil, and life cycle cost of use and disposal must be considered when selecting synthetic sorbents for storage and immediate availability.
- All sorbents used for oil spill cleanup should be recovered and disposed of through standard procedures (See Section 11, Disposal). The small-grained, loose-type sorbents are very difficult to remove from water, adding delay and cost to the operation.

8.3.1 Application of Straw: Baled straw is a mass of stalks that have been reduced to this state by a thorough tumbling in the threshing process. Baled straw is normally used for stock bedding

because of its toughness and sorbency. In tests, straws—oat, wheat, and rice—have been found to collect a large proportion of their ultimate total of oil in the first few minutes after contact with oil. Fifty-gram samples of the three straws deployed over a medium gravity crude (Sp. Gr. 0.795) for five minutes revealed an average removal of 207 ml. of oil and 8 ml. of water. A 15-hour test with the same oil averaged recovery of only 245 ml. of oil and 37 ml. of water. Therefore, straw should not be left on water for prolonged periods, as its effectiveness is greatly diminished after the first few minutes. As time on water increases, the risk that the oil-soaked straw will sink also increases.

Because of its low cost and capability of being mechanically spread over large areas, straw is most effective on land, beaches, or shorelines. Land and beaches contaminated with a viscous oil that has not penetrated the sand or rocks can be cleansed readily and cheaply using straw. Straw also is effective along stretches of shoreline where oil on water is about to reach the shore. Straw should be spread plentifully, as it serves a dual role: it collects the oncoming oil and prevents or reduces the amount of oil that reaches the beach itself. Under these circumstances, the amount of straw spread, time on water, and removal should be carefully controlled.

Straw also will make a very effective dam either in baled form across shallow water or in dispersed form behind a wire fence in deeper water (Figures 8-1 and 8-2).

Straw spread over water will consist of many small pieces of stalk. These small pieces will find their way into places difficult to reach for removal. Therefore, try not to use straw as an oil sorbent near an open rocky shoreline where it cannot readily be removed.

Straw on open waters is difficult to retrieve. Special recovery sieves are needed and, even then, all of it will not be recovered. Open water spreading of straw should be avoided unless the spill is small, contained, and mechanical means are not available to remove the oil.

Spreading the straw on an oil spill on water precludes the pumpability of the oil, rendering mechanical removal devices useless. Therefore, do not spread straw on an oil spill that can be removed more effectively by pumps or vacuum units.

STRAW SKIMMER FOR FLUCTUATING STREAM FLOW

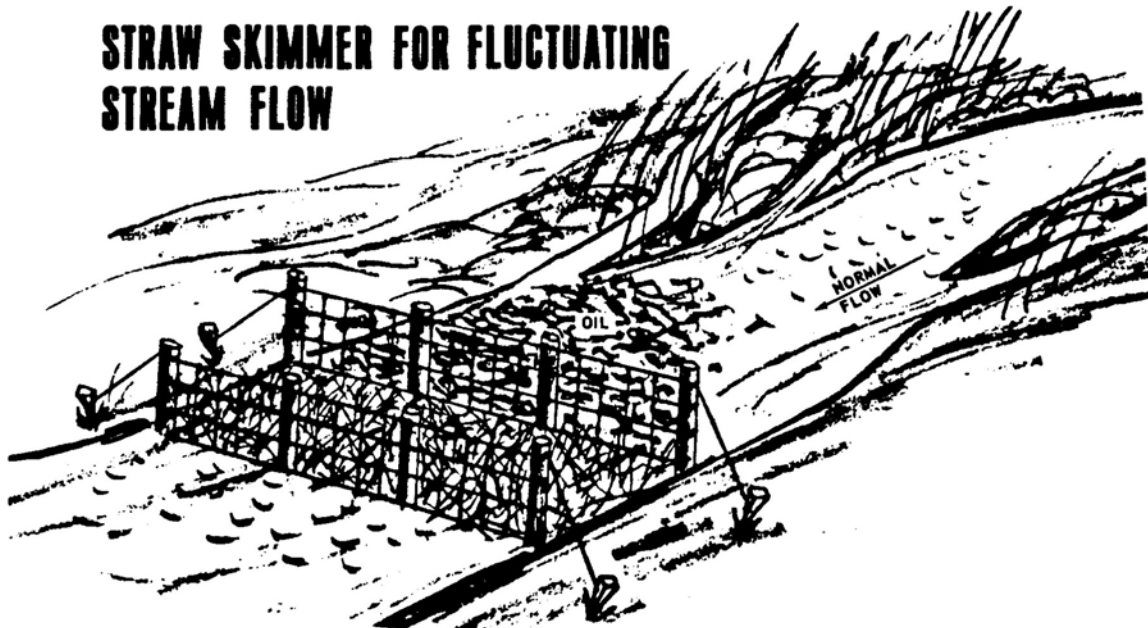

Figure 8-1: Straw Skimmer

Stretch wire fence across stream and anchor securely. Straw is placed on upstream side of fence. This type of installation should be used where the stream banks are of sufficient height and movement of water is relatively slow.

STRAW SKIMMING INSTALLATION

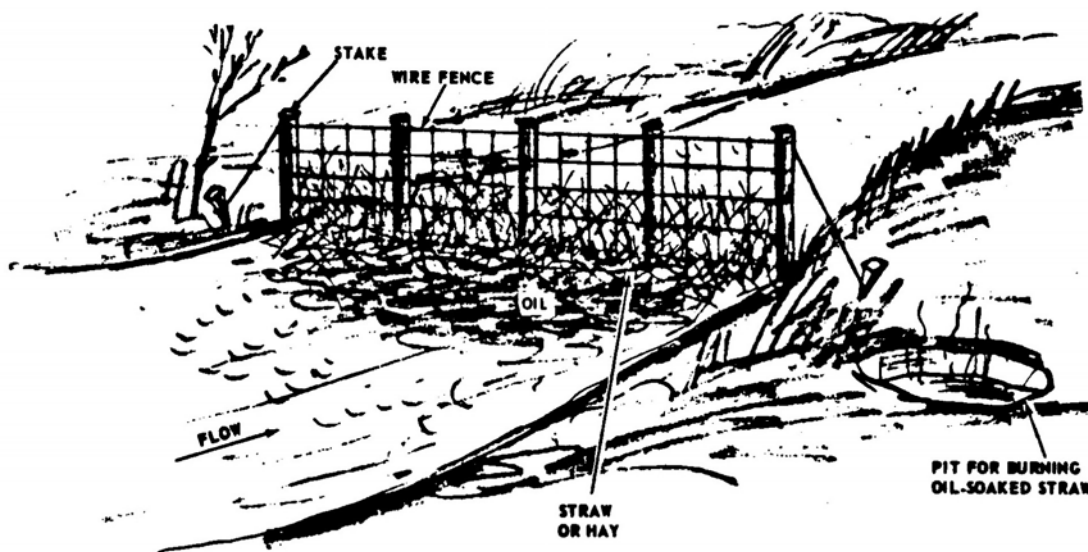

Figure 8-2: Straw Skimming Installation

The ordinary straw skimmer may not be used effectively in a stream having a constantly changing flow direction. When this type of skimmer is installed in a body of water that is subject to fluctuating flow movement, the straw must be held in place by wire fence on both sides of it.

8.3.2 Using Synthetics: Synthetic sorbents play an important role in recovering oil. Besides being used by oil spill cleanup contractors, they are widely used to remove oils from such areas as floors of factories, machine shops, and electrical oil filter equipment. All oil spill cleanup contractors stock large supplies because synthetic sorbents serve a vital need. These products are more expensive than straws but work well in certain situations where the straws should not be used. Like the straws, synthetic sorbents would not be economical or efficient to use where mechanical—pump or vacuum—removal of the spill is possible.

Synthetic sorbents can be divided into five categories:

8.3.2.1 Fine to Medium Grain: In this form, the product is difficult if not impossible to remove from water. It should not be used for retrieving oil from water unless marketed in a form—pad, boom, etc.—that is specifically approved for use on water. Fine grain sorbents are best used to clean up oil from terrain and to sorb oil out of oil-soaked lawns. The fine grain particles should not be used on beaches, as raking will only mix the oil-soaked sorbent with the sand, adding to the removal problem. This type of product should be stocked in those isolated areas that are exposed to oil spills that may trespass private lawns, golf courses, etc.

8.3.2.2 Coarse Grain (Particulate): This versatile sorbent can be deployed by hand or machine. The pieces are large enough to be easily removed by rakes or sieves from beaches, water, or terrestrial areas. Because of its relatively high cost, its use should be limited to the cleanup of small spills that other sorbents or mechanical units cannot remove more rapidly and at less expense. Using particulate in open rocky areas is not advisable, as the pieces are not connected and, therefore, could be difficult to remove.

8.3.2.3 Pads: These types of sorbents are marketed in cartons or bundles weighing 15 to 25 pounds and containing 100 to 110 pads, each approximately 12 to 24 inches square and between one-quarter and one-half inch thick. These pads are the most commonly used of all the synthetic products. Some have grommets in one corner so that they can be connected for isolating in a specific area and for quicker removal. The pads must be manually deployed, and usually are recovered by hand. They are commonly used to clean up small spills or to polish the cleanup of larger spills. The pads containing true absorbent polymers are especially effective for final cleaning and polishing in most cases. These pads can be used effectively for absorbing oil out of rocky crevices and hard-to-reach places. They become entirely impregnated with oil when spread on a thick layer of medium to light gravity oils. When the spilled oil is thin—such as insulating oil—only one face of the pad and its perimeter get oil-wet, requiring manual turnover. Pads are not effective in sorbing a viscous material from the water or a beach.

Some types of pads are fibrous, which permits wringing out the oil and reusing the pad. This is not recommended or commonly done because the labor cost of wringing the pad exceeds the initial cost of the pad. There is also danger of personnel contamination or of reintroducing contamination into the environment. However, if a temporary shortage should exist, then wringing could be justified.

8.3.2.4 Rolls: Rolls have a more limited use but offer some advantages. Since the sorbent material is in a rolled form, it is more concentrated, thus requiring less storage space for equal

poundage. Rolls can be used on a beach by spreading out the entire roll at the water's edge to receive an oncoming light gravity oil spill—such as diesel fuel or insulating oil. This is one case where using sorbent rolls is preferable to using straws. The rolls also can be used as footpaths for personnel and wheelbarrows or as blankets for temporary storage of oil-soaked material to prevent dripping oil from recontaminating clean areas of beaches, docks, etc. Pieces can be cut from the rolls when sections larger than the pads are needed. Storing some rolls of sorbents in areas of high oil spill exposure may well be worthwhile.

8.3.2.5 Other Forms: Synthetic adsorbent or absorbent material is also marketed as pillows and booms, and adsorbents as a mass of thin strips, much like strips of cellophane. The pillows can resemble house pillows and are covered by burlap or other porous material of various shapes. Some pillows are grommeted for joining for easier use and recovery. Sorbent pillows can be used to plug leaking boom sections, to recover oil in rocky areas, and to make booms by tying together several pillows.

Sorbent booms are available, manufactured much like the pillows but longer, in 20- to 25-foot sections. They do not have a skirt or tension member and should only be used to sorb thin, light gravity oil films along a relatively short distance. Sorbent booms are relatively expensive and cannot be reused, so their use can be justified only for isolated and special incidents. This type of sorbent would work best across a slow-moving, narrow body of water with a widespread, thin film of high gravity oil.

Synthetic sorbents also are available in thin strips of vitreous material that can be tangled to form a loose mass or paralleled and tied to a pole to form a mop, much like a household mop. The tangled mass can be thrown into a viscous spill, allowed to sorb the oil, then be removed manually or by a specially designed mechanical apparatus. This method of removal is effective on viscous oil at shoreline locations where a considerable amount of debris is present. However, before employing this method, compare its cost with the cost of first removing the debris and then removing the oil by other means. When the tangled mass type is used, it usually is discarded after recovery, since the labor cost of squeezing the oil from the base, loosening the fibers, and redeploying will exceed the cost of a new unit.

The mop types are used manually for removing a spill from difficult-to-reach places such as crevices, rocky areas, between floating craft, under confined piers, or dock facilities. Consideration should be given to an alternative absorbent type of product that may provide a more complete removal of many oils if a pad type product is practical to use.

8.4 BIOLOGICAL DEGRADATION

The waters of the United States contain many species of microorganisms, which increase in abundance between colder waters and warmer waters. These microorganisms consume hydrocarbons (oil) as an energy source. The natural microorganism process of consuming and thereby removing oil from water is well recognized and is the reason given for the disappearance of much oil spilled in the waters throughout the world. However, the use of the process as a practical method of removing oil from inland or coastal waters is questionable.

Detergents and dispersants can be used to break up an oil spill into smaller oil droplets, permitting more rapid decomposition of the oil by microbial action. The ecological effects of this use are debated among marine biologists. Some of these biologists advocate the use of chemicals to disperse the oil in waterways, while others are opposed to the use of either detergents or dispersants under any circumstances, claiming the oil and chemicals form a more toxic mixture.

The natural microorganism process alone does remove some oil spilled on the waters, but it should not be expected to materially assist the overall spill cleanup problem other than as a bonus in the cleanup of any residual oil.

8.5 COMBUSTION

This method of oil-on-water removal is effective where the conditions and regulations permit. Combustion is the most inexpensive way to remove oil, but it also is the most hazardous. Many factors should be considered when contemplating burning oil floating on water, including:

8.5.1 Ignition

It is nearly impossible to ignite a thin layer of low-gravity oil floating on a large body of cold water because of conductive heat losses into the water. If oil is lighted, steam is generated, which chokes off oxygen and smothers the flame. Burning is not a complete process; therefore, other methods are required to remove the residual oil.

Several manufacturers are demonstrating so-called “wicking” agents, which act much like a wax candle. When spread on oil and set afire, heat from the burning wick reduces the viscosity of the surrounding oil, which then is drawn into the burning area. The wicks insulate the water from much of the heat combustion. These “wicking” agents are bead-like and some can be recovered and reused. The cost of the “wicking” agent, the equipment to spread and recover it after burning, and the cost of cleaning and restoration must be considered in estimating the overall cost of cleaning up an oil spill by the combustion process.

Generally, the longer the spilled oil remains on the water, the more difficult it is to ignite and burn, primarily because the volatile components—which are most easily burned—evaporate quickly. This method of removing spilled oil from water offers some limited use but, in general, is not operationally practicable.

8.5.2 Smoke

Permits from air pollution agencies are required to burn oil off water because the poor combustion causes heavy smoke. Keeping a contained oil spill burning will consume the containing equipment, unless earthen or fireproof devices are used. This special equipment will greatly increase the associated cost of containment. Burning of oil spills in or near public or private structures should never be considered.

8.5.3 Wind and Wave Action

Wind and wave action has a cooling effect through convection and adds greatly to the loss of heat.

8.6 SINKING AGENTS

Warning: The use of agents to sink the oil should never be used, since this method is irretrievable and illegal in U.S. waters.

This is a process of removing an oil slick from the surface of water by simply spreading a hydrophobic material over the oil that becomes coated with oil then sinks in the water. The process is not accepted. The mechanism of sinking and the depth to which the oil-coated material will sink are not fully known yet. These factors vary with the properties of the oil, water, and the material used, as well as prevailing climatic conditions. The oil retentive quality of the material used also can vary with time and changes in climatic conditions. This may then result in release of the attached oil, permitting it to resurface.

The effects of this method are toxic to the environment. Wildlife regulatory agencies are opposed to the use of sinking agents because this method transfers oil from the surface of the water to a depth where it may be even more harmful to the ecology of the area. The use of this method also would be relatively ineffective and too costly to use on a thin oil slick.

BLANK PAGE

CHAPTER 9 OIL REMOVAL ON WATER

9.1 OIL REMOVAL METHODS

Once an oil spill on water has been contained by any of the means described in the containment section above, it must then be removed using the most effective method—one that has the lowest cost and causes the least harm to the ecology of the area.

Like containment, removal of an oil spill from the surface of the water can be a complex task requiring a variety of methods. Mechanical units such as skimmers or vacuum trucks may be used. In some spills, the use of sorbent materials to soak up the oil may suffice. Even nature can play a role through the process of bacterial degradation. Under special conditions, chemicals may be used to disperse the spill in the water column. Finally, the oil spill may be removed by burning it off or by spreading heavier-than-water granules on it and sinking the oil to the bottom. (Note: U.S. regulations prohibit the use of sinking agents.)

See Chapter 8 for a description of sorbents, chemical, and biological processes, and other nonmechanical methods of oil removal. Mechanical methods of oil removal are discussed in the rest of this chapter.

9.2 VACUUM UNITS

Using a vacuum unit is one of the most acceptable methods for removing a contained oil spill, unless the spilled hydrocarbon is too viscous to be sucked into the unit. A vacuum unit on a truck bed combines the spill removal and transportation functions, saving several steps that would otherwise need to be taken without such a unit. This contributes to lower cleanup costs.

Although the vacuum truck is one of the most commonly used tools in the oil spill cleanup business, it does have some disadvantages that should be considered.

- It is a large, expensive, mechanically complicated unit
- The size and weight preclude accessibility to many oil spill areas
- Proper maintenance is mandatory and is expensive if the truck is not used regularly

A small, skid-mounted vacuum unit may serve well in an area where small oil spills predominate. This kind of unit can be mounted on a trailer for transporting it to a spill site. A skid-mounted unit can be towed along a beach by a tractor. Such a unit usually can be designed for the needs of an area and built by the nearest tank or welding shop.

Vacuum units are most effective when a spill has been contained in thick pockets of relatively pure oil. Because of the high per-hour cost of operating vacuum units, their use will not be the most cost-effective method of removing small, or widely dispersed, thin layer oil spills. Additionally, large amounts of debris can clog hoses and pumps. In such a case, prescreening of the debris is required (See Figure 9-1).

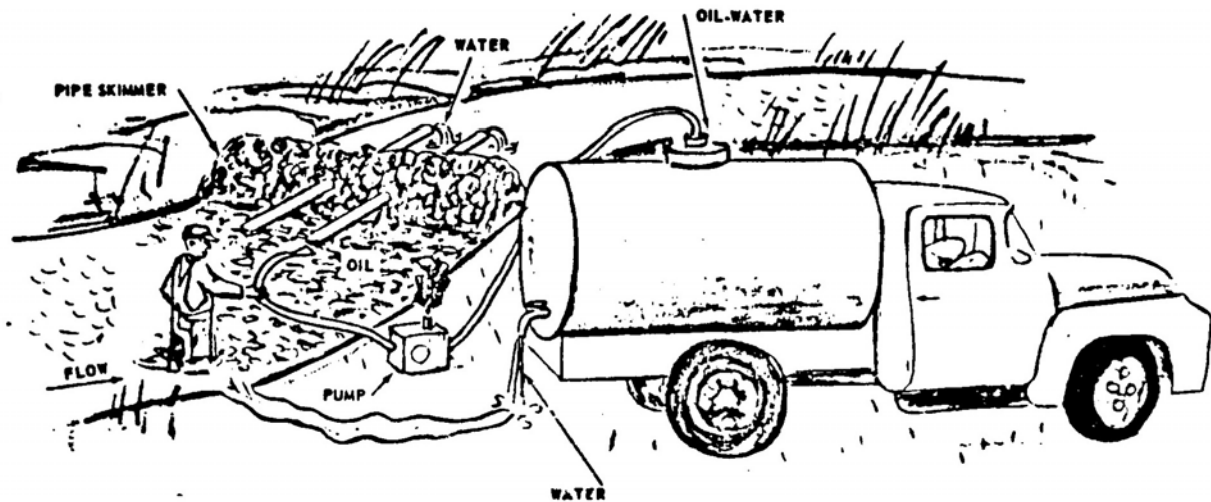

Figure 9-1: Tank Truck

The oil-water mixture is pumped into the top of the tank and, after separation of oil and water, the water may be returned to the stream by opening a valve at the bottom of the tank and running the water through an oil sorbent filter medium to remove most traces of residual oil. Certain synthetic oil sorbent filter designs are commercially available for this purpose. Sufficient settling time should be allowed to permit a fairly complete separation.

9.3 SKIMMERS

Many mechanical devices have been developed to receive and physically remove spilled oil from the surface of a water body. These devices are called skimmers. They vary in shape, size, purpose, and cost. Skimmers may be simple homemade units made from scrap parts costing little, to sophisticated, complex units priced at several hundred thousand dollars each.

The two basic types of skimmers used today are:

- Suction units
- Oleophilic units

Although suction units vary greatly in design and purpose, they all require some sort of suction device to remove the entrapped or contained oil. The above basic units may be subdivided into five categories:

- Enlarged suction head
- Floating weir
- Oil-water trap
- Dynamic inclined plane
- Cyclone operation

Oleophilic units use a material to which floating oil will adhere. The oil is removed from the material by various systems. Several types of oleophilic materials and removal systems are used in this skimmer category, which may be subdivided into:

- Belts
- Drums
- Disks
- Ropes

Unfortunately, there is little versatility in skimmer design and purpose and there is a fairly rigid set of conditions under which skimmers will operate properly. All have varying difficulty with wave action. Some are extremely sensitive to air intake and the subsequent loss of suction and most cannot be used in debris-laden waters.

Generally, an oil skimmer should meet these criteria:

- Be quickly deployable during worse-than-average climatic conditions
- Be able to handle small solids and debris without damage
- Use self-priming and/or diaphragm type pumps
- Be rugged and dependable for continued operation with minimum maintenance
- Be able to operate in shallow waters (10 in. to 20 in.)
- Be as portable as possible

9.3.1 Suction Types

9.3.1.1 Enlarged Suction Head Skimmers: Enlarging the head attached to the end of a suction hose increases horizontally the area over which suction is exerted. Such a head floats on the water with the suction opening at the oil-water interface. See Figure 9-2 for three different types of such heads.

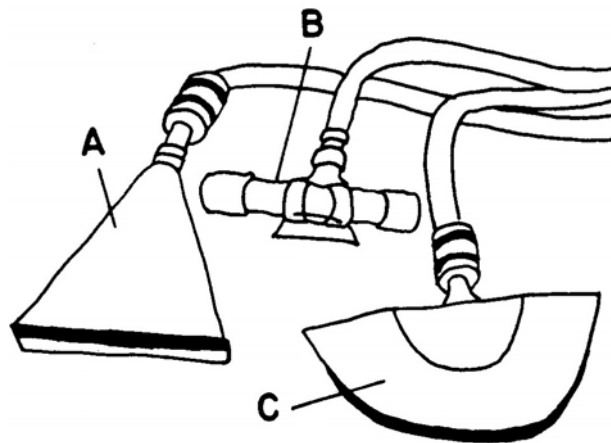

**Figure 9-2: Three Types of Enlarged Suction Heads
(A) Duckbill, (B) Pipe Extension, (C) Flexible**

A flexible head is more versatile than a rigid type, as it will contour itself to small wave action, maintaining its effectiveness. The capacity of a unit will depend on the size of the head, size of the suction hose, and pump capacity. A delicate blending of all three factors is needed for effective results.

These units will operate in shallow water, but they are subject to being clogged by debris. They also can draw air, which will impede operations unless self-priming pumps or vacuum units are used. Care should be taken when deploying the units in choppy or debris-laden waters. These are relatively low-cost skimming units.

9.3.1.2 Floating Weir Skimmers: Floating weir skimmers are mechanical devices that float on water and permit oncoming oil to pass over its adjustable weir plate onto an area where the oil is confined and then sucked or pumped off. The units are widely used and are available in a variety of shapes, sizes, and capacities. Figure 9-3 illustrates the weir skimmer action.

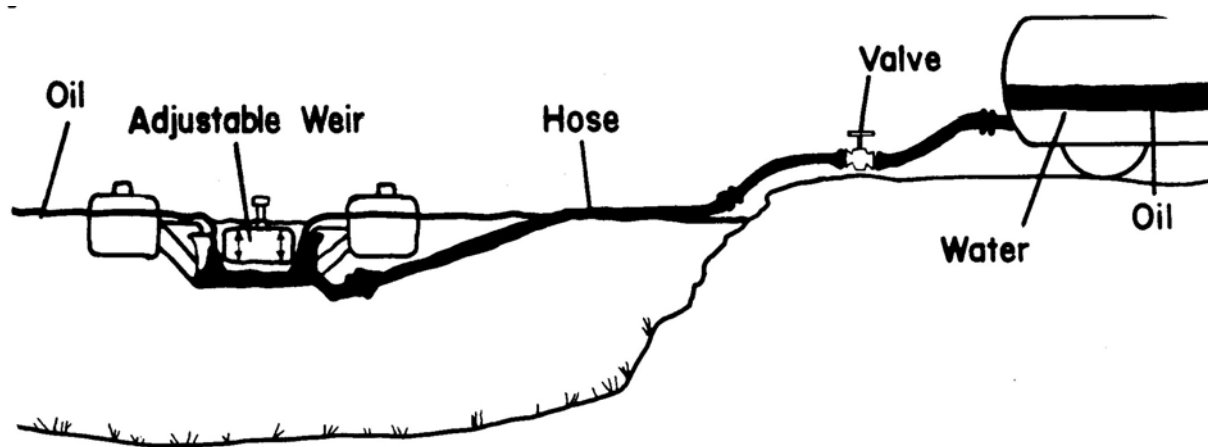

Figure 9-3: Weir Skimmer Operation

These units, like the suction head skimmer, are portable and can be deployed quickly. The cost of such units is supportable when compared to that of the large units requiring service crews and craft. They can be located in the center or near center of a contained spill or maneuvered about in the contained area by ropes handled by two persons.

The capacities of floating weir skimmers depend on the sump size of the weir, size of suction hose, and capacity of the pump. The units are very effective in medium- to light-gravity oil spills where the water is quiet and debris-free. The units are generally light in weight and buoyant, which makes them susceptible to failure in medium choppy water. They can be clogged quickly in debris-laden waters and will usually require personnel to adjust the weir or unclog the screen.

Using a weir skimmer requires practice and experience to be most effective. Weir adjustments, relocation, and cleaning of debris usually require constant attention from the crew, all of which adds to the cost of the operation. The use of such units should be limited to those times when other types of spill removal are not justified.

9.3.2 Oleophilic Types: These types operate on the principle that oil rather than water will adhere to the oleophilic part of the unit, which is immersed in the oil. As the part is mechanically removed from the spill, the adhering oil is either wiped, scraped, or squeezed off into recovery tanks. Metal and plastic surfaces are used for the oleophilic parts. These skimmer types come in various forms and shapes.

Any piece of rope dragged through an oil spill will adsorb some oil. The larger the rope or the greater the surface area exposed to the spilled oil, the greater the removal. Also, the more oleophilic the rope material, the more oil and less water that will be removed.

One manufacturer has applied this principle and markets a rope type skimmer. This unit is widely used and is available with assorted sizes and lengths of rope. The rope consists of a basic tension core to which is interwoven additional oleophilic material to enlarge the overall diameter and increase many-fold the surface area that is exposed to a spill. These ropes are available in sizes with outside diameters ranging from 4 inches to 36 inches and can be provided in any length.

The rope is deployed into an oil spill as a continuous loop, moored at one end around an anchored, floating, tail pulley. The oil adheres to the rope and is removed by a wringer as it passes through a power machine located at the opposite end of the rope extension. The power units that propel and wring the rope are available in a variety of sizes and can be driven by gasoline, electric, diesel, or pneumatic engines.

This type of skimmer is effective and versatile. It recovers little free water, will operate in light or viscous oils, and is not too troubled by debris. The units are operable in shallow or deep waters, wherever the trail pulley can be stationed. Portability allows for reasonable response within a limited area. The main disadvantages are rope maintenance and relocation costs. Care has to be taken to prevent recontamination from dripping oil as the rope approaches the unit. Other sorbent materials on the water, dock, or ground around the power unit may be needed for this protection.

BLANK PAGE

CHAPTER 10 OIL SPILLS ON LAND

10.1 MIGRATION OF PETROLEUM PRODUCTS IN SOIL AND GROUNDWATER

Petroleum oil spills on land are a concern for the electric industry since the majority of facilities do not spill oil directly into waterways but, rather, will migrate oil into groundwater sources. The actual impact of land spills will vary widely and will depend on such factors as volume of spill, type of soil, nature of groundwater system, and the weather. It is, thus, nearly impossible to outline procedures that are universally applicable for all circumstances. The mechanisms of migration are complex, but where sufficient geological data are available, it is possible to predict whether a given amount of oil is likely to reach a water table or to estimate the depth to which it is likely to migrate in the soil. When a large amount of oil is involved, skilled geological and hydrological personnel may be helpful in determining problem areas.

In order to have a better understanding of the potential hazard of oil on water supplies and/or groundwater, a discussion of soil characteristics and water hydrology is necessary.

To anticipate effectively the behavior of oil spilled on soil requires detailed knowledge of the local geology and groundwater conditions and of the principles described here. The geology of most areas of the United States has been mapped quite thoroughly and groundwater conditions, where they are important, are well understood. Leading sources of such information include:

- United States Geological Survey, Groundwater Division (offices in most major cities and State capitals)
- State water resource agencies (described by various titles)
- State Geological Surveys (usually in the State capital, but often associated with a State university)
- University geology departments
- City water departments

10.2 ROCKS AND SOIL

Most rocks and soils are composed of small fragments or grains such as sand. The irregular shape of these grains, when they are pressed together, creates small openings or voids. A quantitative measure of the total column of the voids is the porosity of the rock or soil. It is within these pores that fluid may be contained. If the pores are interconnected, the rock is permeable; that is, a fluid can pass through it. Permeability is a quantitative measure of this property. Materials such as clay, silt, and shale are called impermeable because they have extremely small pores, are poorly interconnected, and fluids cannot pass readily through them.

The more common rocks and soils are sedimentary. Usually they occur in distinct layers or beds as a result of successive deposition of different types of rock material. Such bedding is commonly exposed in road cuts. The beds may be horizontal, but more often will slope or “dip” in some direction. This dip, in addition to the varying porosity and permeability of the different layers, does much to govern the movement of fluids underground.

One particular rock, limestone, is especially soluble in water. Limestone that is near the surface sometimes develops large openings and fissures that range from less than an inch to many feet across. The more spectacular examples include great caverns such as Mammoth Cave in Kentucky and Carlsbad Caverns in New Mexico. The rock in such caverns clearly has extremely high porosity and permeability. In other instances, limestone may have very low porosity and permeability.

Crystalline rocks, such as granite, marble, and quartzite, usually are not porous. Frequently, however, such rocks are cracked or fractured to some depth, and a certain amount of fluid may exist in and move through these openings.

10.3 GROUNDWATER

In most parts of the United States, free water exists at some depth in the ground. In many areas, enough is present to provide a major part of the water supply for towns and cities, as well as rural areas. In areas where groundwater is used extensively, products spilled on the ground may create risk of contamination.

The source of most groundwater is precipitation over land, where water is adsorbed by porous soils and rocks at the surface. Other important sources are rivers and streams that may lose water into the subsurface. Details of a hypothetical total groundwater system are shown in Figure 10-1.

Moisture is present to some degree in practically all soils. Starting at the surface, moisture generally increases with depth in a zone of partial saturation called the vadose zone. The depth at which water completely fills the pores in the soil defines the beginning of the zone of saturation. The upper surface of this zone is the water table, and the water in the zone is groundwater.

The position of the water table is revealed by the level to which water rises in wells. The water table usually is an undulating surface that conforms in a general way to the topography of the land. It fluctuates seasonally, rising during rainy seasons and falling during dry periods. Immediately above the water table is the capillary zone. This zone may vary in thickness from less than an inch in coarse, permeable soil to 15 inches or more in very fine-grained, low-permeability soil or rock. Water in the capillary zone will not flow, since it is held by capillary forces that are stronger than gravity. The capillary zone is important because its nature and thickness determine the spreading characteristics of oil that reaches the water table.

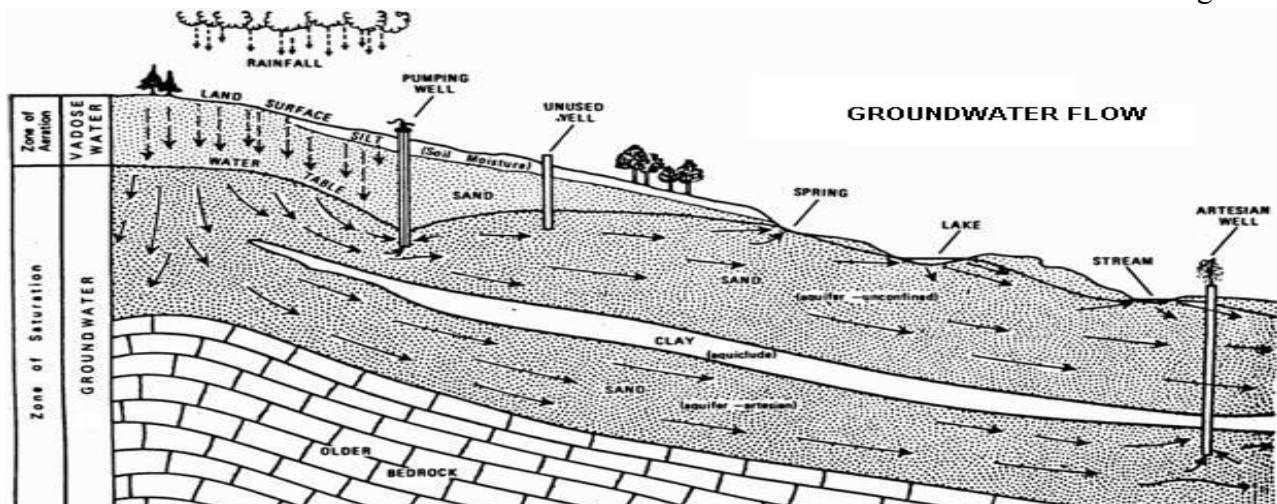

Figure 10-1: Hypothetical Groundwater System

Most layers of rock or soil in a groundwater system can be classified as either aquifers or aquicludes. An aquifer is a layer of rock that is sufficiently permeable to transmit water in usable quantities to a well or spring. An aquiclude, on the other hand, is sufficiently impermeable to bar the passage of water. An aquifer where the water table is not separated from the surface by an aquiclude is an “unconfined” aquifer, and groundwater associated with it is free to move by gravitational forces. An aquifer that is overlaid by an aquiclude is a confined or artesian aquifer. Artesian water normally is not free to move by gravitational forces, but is under sufficient pressure to rise above the top of the aquifer in a well or spring. The height to which artesian water rises at such a discharge point is a measure of the pressure head created by the weight of the water in areas of the aquifer at higher elevation.

In certain situations, a body of groundwater may be hydrostatic in that, essentially, it does not move. In most cases, however, groundwater is constantly in motion. Water in an unconfined reservoir is under atmospheric pressure and moves laterally under the influence of gravity toward a point of discharge such as a well or spring. The direction of flow will, as a rule, roughly parallel the land surface. Water in an artesian aquifer is under a pressure related to the highest elevation of the aquifer and will move toward the point of lowest pressure. This point may be a well or, more commonly, an area where the overlying aquiclude is locally super-impermeable and permits slow upward leakage into higher beds. So long as the system remains artesian, the rate of leakage cannot exceed the rate at which new water is entering the aquifer at a higher elevation.

Certain cities and industrial areas draw many millions of gallons daily from groundwater reservoirs. The sites and relative production rates of the wells can disrupt normal flow patterns significantly. Complete reversal of direction in limited areas is not uncommon. In such areas, fortunately, considerable data are usually available for use in solving groundwater problems. In complex situations, the direction of flow is determined by drawing maps based on pressure data from wells in the area.

The rate of movement of groundwater is usually overestimated by most people, who think of it in terms of a surface stream. A more realistic comparison is the flow in a large lake where water moves imperceptibly toward a single outlet. Measured rates of groundwater movement vary markedly, from many feet per day to a few feet per year. The range is so great that the data are of little use in terms of specific locations. The water in a typical sand aquifer might move from several inches to 4 or 5 feet per day. The rate in a limestone or gravel aquifer could be much higher. The rate of flow depends mainly on the permeability of the aquifer and the hydraulic gradient or slope of the water table. To measure the flow rate of groundwater directly is extremely difficult and is seldom used in practice. Such data, when required, usually are calculated by hydrologists using permeability and pressure data from wells and cores of the aquifer or from actual pump tests.

10.4 BEHAVIOR OF SPILLED OIL IN SOIL

An accidental spill of oil or its products may occur suddenly or it may occur slowly over a long period. The physical behavior of the spilled material is the same in each case, varying only in time and extent. A slow leak over an extended period is not detected until oil appears at some point where it is not wanted. By then, the problem of controlling the spill may be very difficult and expensive.

Spilled oil commonly migrates along artificial fills, such as pipeline trenches, foundation fills, and utility conduits, in a manner somewhat related to its behavior in natural soils. Such excavations often are backfilled with material more permeable than that removed. These excavations consequently offer a migration route of minimum resistance, and any fluid will tend to move along them more rapidly than through natural soils.

Oil spilled on undisturbed ground will tend simply to move downward, under the force of gravity, while spreading laterally to some degree. The rate of movement depends on the viscosity of the oil and permeability of the soil. If the spill area is essentially round, the general shape of the area of passage is a cone, modified by the nature of the soil layers the oil passes through (Figure 10-2). The downward movement eventually will be interrupted by one of three events: the oil will be exhausted to immobility, it will encounter an impermeable bed, or it will reach the water table.

10.4.1 Exhaustion to Immobility

As the oil moves downward through the soil, a small amount attaches itself to each particle of soil contacted and remains behind the main body of oil. Where the spill is small relative to the surface area available for contact in the zone of migration, the body of oil is exhausted on the way down until the degree to which it saturates the soil reaches a relatively low point called the "immobile" or "residual" saturation. At this point, the oil essentially stops moving. If the condition develops before the oil reaches the water table, the danger of further contamination is greatly reduced. Subsequent rainfall percolating through the soil will carry minor additional amounts of residual oil and dissolved components downward. This situation, however, creates less risk of significant pollution than if the main body of oil reaches the water table.

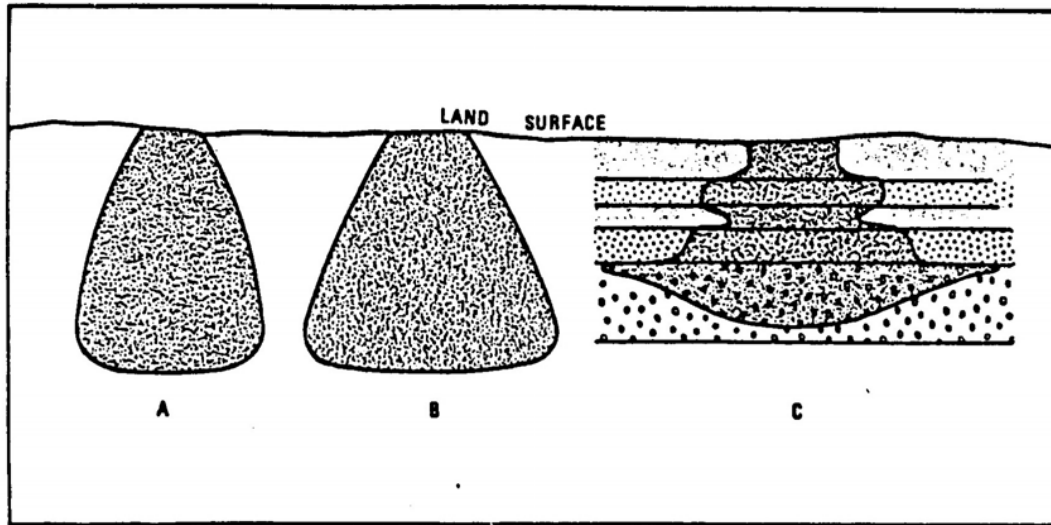

Figure 10-2: Generalized Shapes of Spreading Cones at Immobile Saturation

At the time of a spill, precise and detailed data on the nature of the soil and oil are rarely available. Should they be available, however, the volume of soil required to immobilize the spill can be calculated using the following (saturation) equation:

$$\frac{8.4 \times V}{P \times S_r} = \text{Cubic yards of soil required to attain immobile saturation}$$

Where: V = volume of oil in gallons
 P = porosity of soil
 S_r = residual saturation = 0.1 for light oils

If the depth of the water table is known, the saturation equation can be used to estimate the likelihood that the spilled oil will reach it. To do so, calculate the volume of soil that lies under the surface area of the spill to the depth of the water table. Make little or no allowance for the lateral spread of oil underground. The result will conservatively understate the volume of soil actually available to sorb the oil. If the result, in cubic yards, is less than the value obtained from the saturation equation, a risk exists that fluid oil will reach the water table.

10.4.2 Movement to Impermeable Bed

As the body of spilled oil moves downward, its course is affected by the variations in permeability of the various soil layers through which it passes. Should the oil encounter an impermeable layer, it will spread laterally until it reaches immobile saturation or until it comes to the surface where the layer outcrops. Should the latter occur and enough oil is still in motion, a second cycle of soil contamination will begin (Figure 10-3). These events can occur only if no effective water table exists above the impermeable bed. The condition is most common in an arid region or during a dry season and, as a rule, only exists within several feet of the surface.

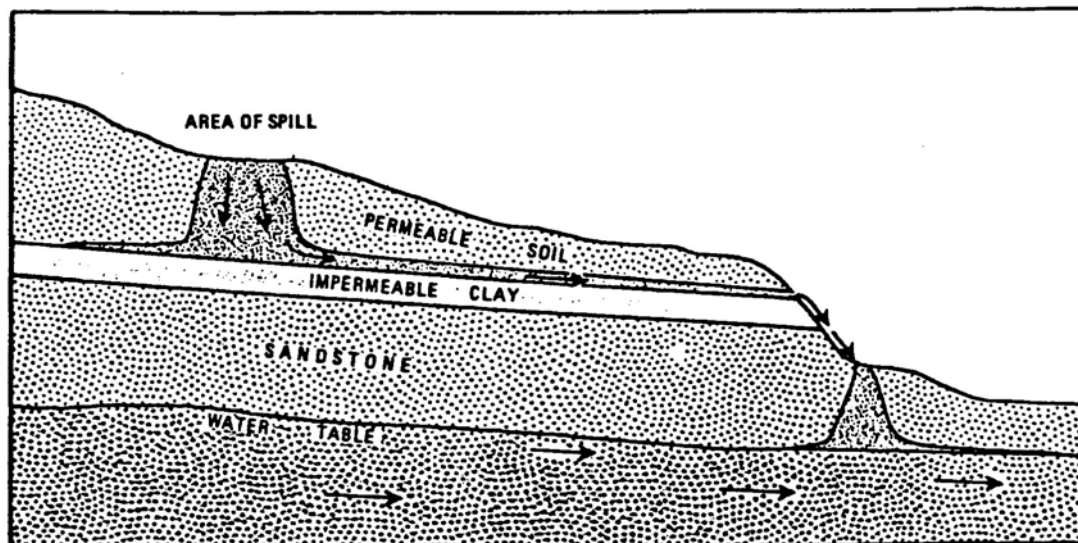

Figure 10-3: Demonstration of Possible Migration to Outcrop, Followed by Second Cycle of Groundwater Contamination

10.4.3 Movement to Groundwater

The movement of oil downward to contact the water table usually is the most hazardous possible result of a spill on land. The degree of risk depends on the nature of the groundwater system and the extent to which it is used.

In the capillary zone, immediately above the water table, the water content begins to increase, reaching 100 percent at the water table. In very fine-grained sediments, the capillary zone may be 15 to 18 inches thick; in coarse-grained material, 1 to 3 inches is common. As the descending body of oil reaches the top of the capillary zone, the oil begins to spread over the water table. It spreads in a layer roughly the thickness of the capillary zone and elongated in the direction of the water's movement. The oil continues to move, forming a pancake-shaped layer until it reaches immobile saturation or returns to the surface at a discharge point (Figure 10-4). The ultimate extent of the oil pancake can be calculated, but doing so under field conditions involves so many assumptions and estimates that the result can easily be inaccurate by more than 100 percent. In practice, such calculations must be treated with great discretion. The transport of oil in moving groundwater is governed by complicated mechanisms for which exact explanations are neither possible nor necessary. A few basic facts suffice for practical understanding. Most oils do not mix with water, but simply float on its surface. However, some refined products contain components that are soluble or will diffuse in water to the point where they become offensive and make the water unfit for domestic use. As a rule, the lighter the product, the greater it's content of soluble or diffusible components. These general principles are illustrated in Figure 10-4.

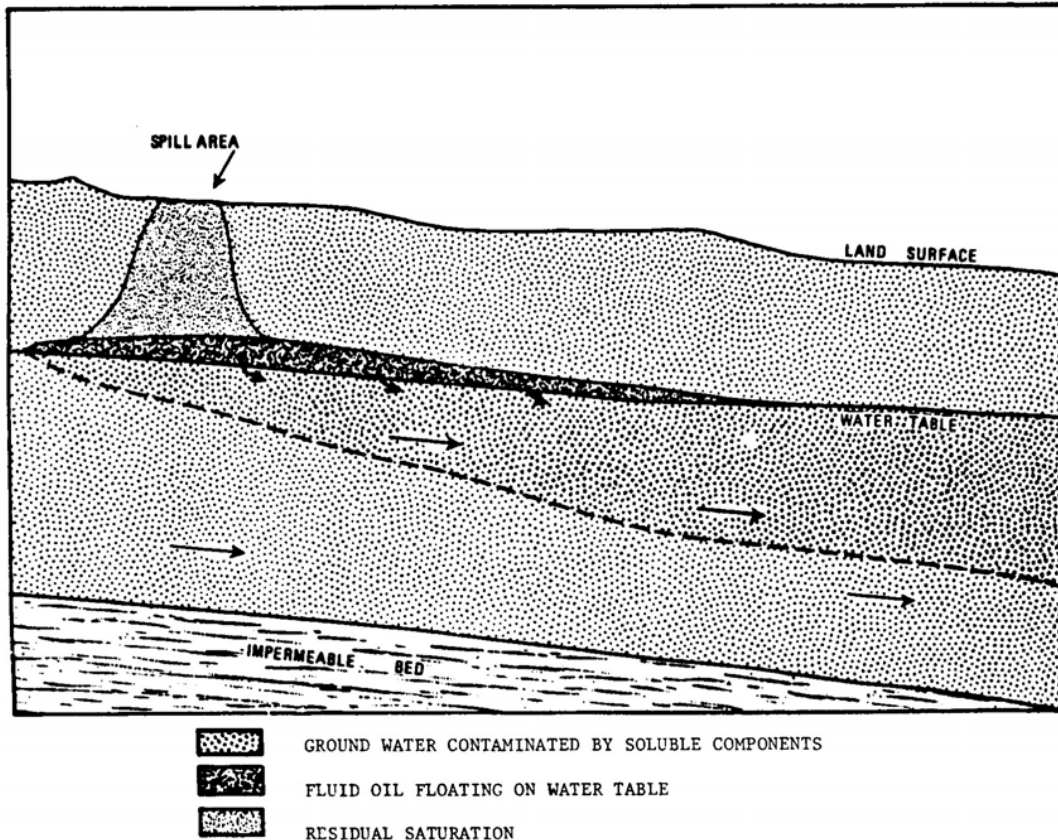

Figure 10-4: Movement to Groundwater

Most of the oil that reaches a water table will be suspended or will float at or near the surface of the water. The oil will tend to move with the water, but it will be adsorbed continually by soil particles that it contacts. Thus, the volume of oil being transported will shrink eventually to zero. If the water table drops, the oil will follow and some of it will be adsorbed by the soil it passes through. When the water table rises, oil previously adsorbed by the soil will be picked up and will continue to move laterally with the groundwater (Figure 10-5).

Groundwater is recharged most commonly by rainfall that infiltrates the soil and percolates downward to the water. Where this water passes through the cone of residual oil, or through the pancake of oil of the water table, it will pick up soluble components of the oil and carry them into the groundwater system. Experiments have shown that some of these dissolved components may be adsorbed by some types of soil through which the groundwater passes. Later, when weaker solutions of the dissolved components enter the same part of the soil formation, they may redissolve the adsorbed components. The net result of these processes is that oil dissolved in groundwater will tend to travel at a lower velocity than the water and thus to persist longer in a given area.

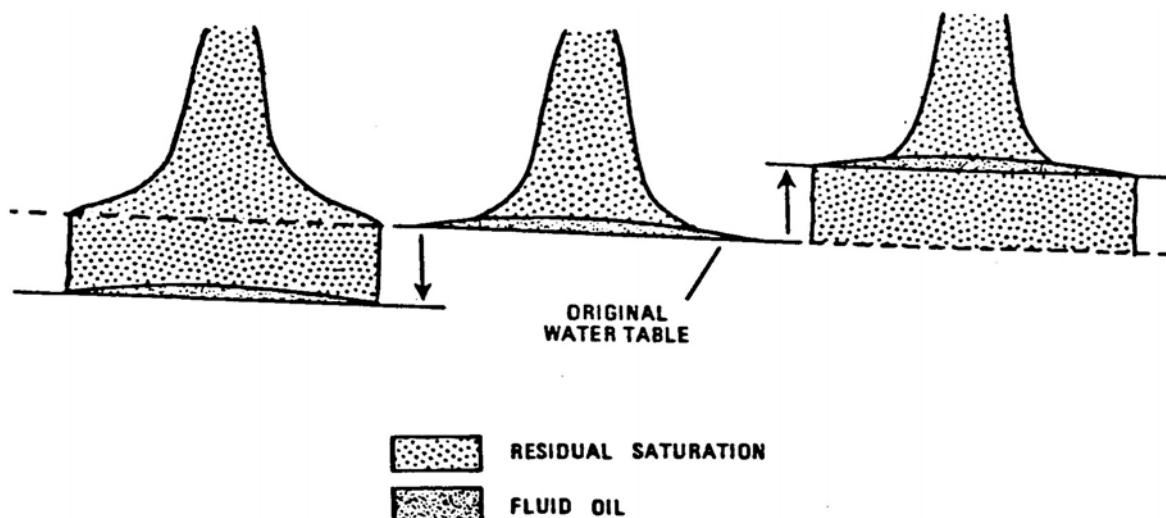

Figure 10-5: Contaminating Effect on Soil Caused by Vertical Movement of Oil on Fluctuating Water Table

10.5 LAND SPILL CONTROL AND RECOVERY

Two steps must be taken following an oil spill on land: immediate measures, which are to be implemented after the spill to minimize seepage; and restorative measures, which are concerned with recovery of oil after seepage has occurred. The methods described in this section can be used at an early stage for either step. More complicated and exotic methods may sometimes be required.

Immediate measures apply to spills that are detected soon after they occur. Oil spreads into the soil fastest immediately after the spill and the rate diminishes rapidly with time. For maximum effect, measures to recover fluid oil at the surface must be taken as soon as possible. Oil may seep into clay soils quite slowly, allowing several hours or even days for surface recovery.

A sandy, gravelly soil, on the other hand, may adsorb the oil in a few minutes. (See soils section in Chapter 6.) The main limitation to surface recovery will be the time required to mobilize suitable equipment and supplies.

If conditions favor an attempt at surface recovery, three basic techniques should be considered: containment, surface spreading, and absorption. The selection will depend on the volume of the spill, the topography, and the nature of the soil and groundwater system.

If the volume of spilled oil is known or can be estimated, the depth to which the oil will penetrate before reaching immobile saturation can be calculated. The calculation will be reasonably accurate only where soils are more or less homogeneous. Still, if the depth to the water table is known, it is easy to estimate whether the oil is likely to initially migrate into groundwater. If the risk exists and if time permits, excavation of the contaminated soil should be considered. Excavated soil can then be cleansed or removed to a disposal site. If excavation is impractical or impossible, plans should be made to recover the oil while it is still localized in the subsurface, using the best available methods.

Seepage often has been discovered during construction projects when oil or oil-contaminated water has flowed into an excavation. This illustrates two key principles: a seepage problem is not necessarily preceded by a surface spill, and oil will migrate under gravitational forces and with moving groundwater. The second point is the basis of the most widely used methods of removing oil from the soil or from an aquifer. These methods embrace three distinct procedures: removal of oil while it is still moving through the soil, but before it has reached the water table; removal of oil floating like a “pancake” on the groundwater; and removal of water contaminated with soluble fractions of the oil.

Effective cleanup of a significant spill on land requires equipment and machinery designed for moving earth, drilling, and pumping. Makeshift devices and methods should, as a rule, only be used temporarily and as a last resort. Speed is vital and every effort should be made to mobilize suitable equipment as soon as possible.

Rarely do conditions favor the recovery of moving oil after it has penetrated the surface, and before it has reached the water table. If the oil has penetrated only a few feet, and if high-capacity earthmovers are available, it may be possible to remove the contaminated soil.

Migrating oil will spread laterally over a layer of clay or other impermeable material. If such a layer lies near the surface, the oil might be recovered in ditches, using techniques similar to those for recovery from the water table (see Chapter 9, Oil Removal on Water, for details). Since such an impermeable layer will protect underlying groundwater, the consequences of forgoing a recovery attempt and allowing the oil to spread to immobile saturation should be considered.

10.6 GROUNDWATER REMOVAL

The primary method of recovering oil from the water table is by creating local depressions and withdrawal points in the water table. Regional water flow is interrupted by these depressions and all movement of oil and water within the depression cone is toward the withdrawal points (Figure 10-6 and 10-7). Oil floating on the water table within the depression is prevented from migrating further by removing it from the surface of the groundwater. The depression is commonly created by sinking wells and pumping water from them. The same result can be achieved with ditches, provided they can be dug to a depth below the groundwater table.

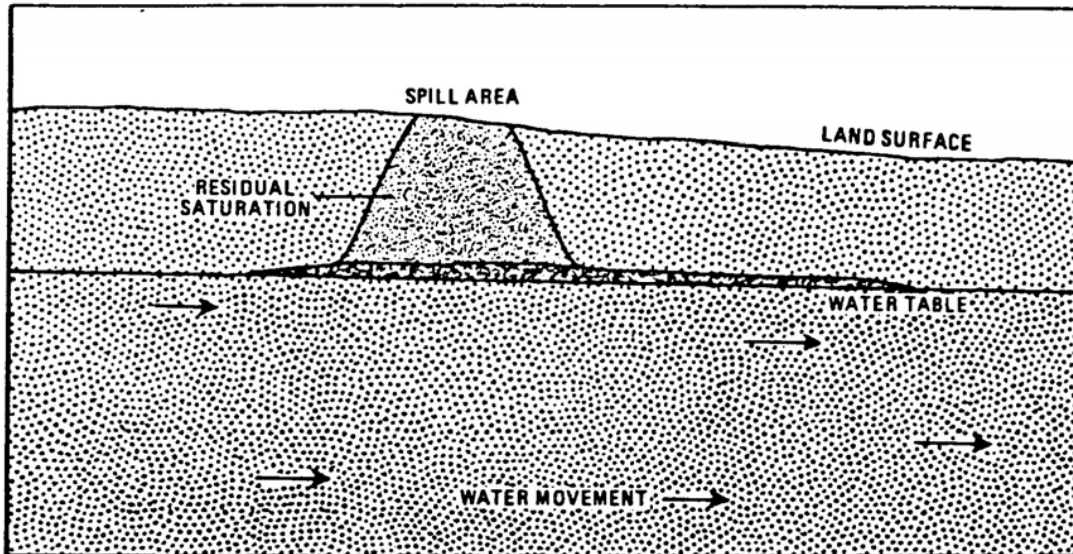

Figure 10-6: Fluid Oil Floating on Water Table and Showing Elongation of “Pancake” in Direction of Water Movement

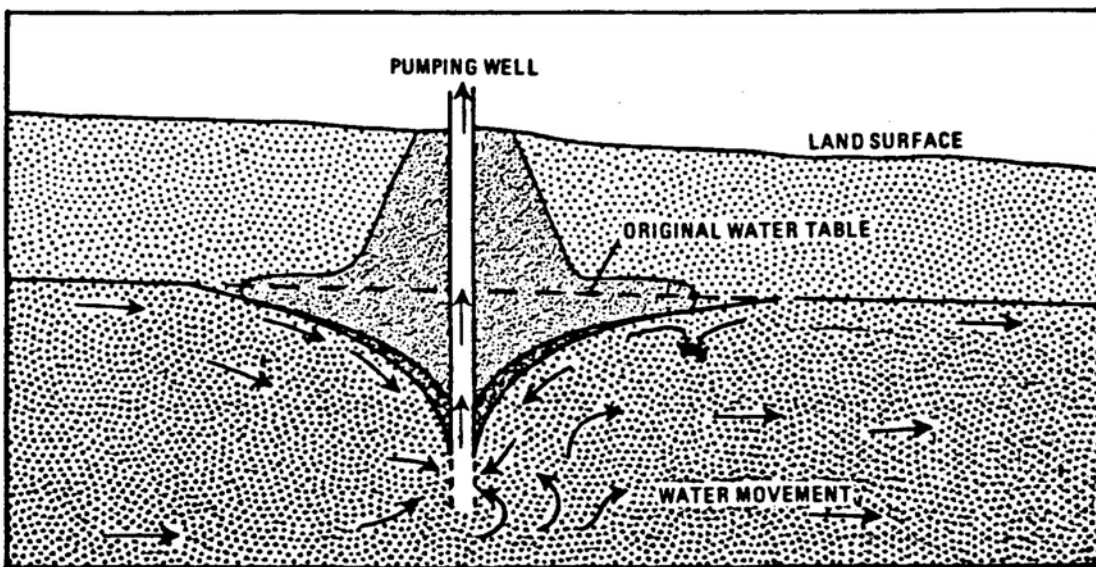
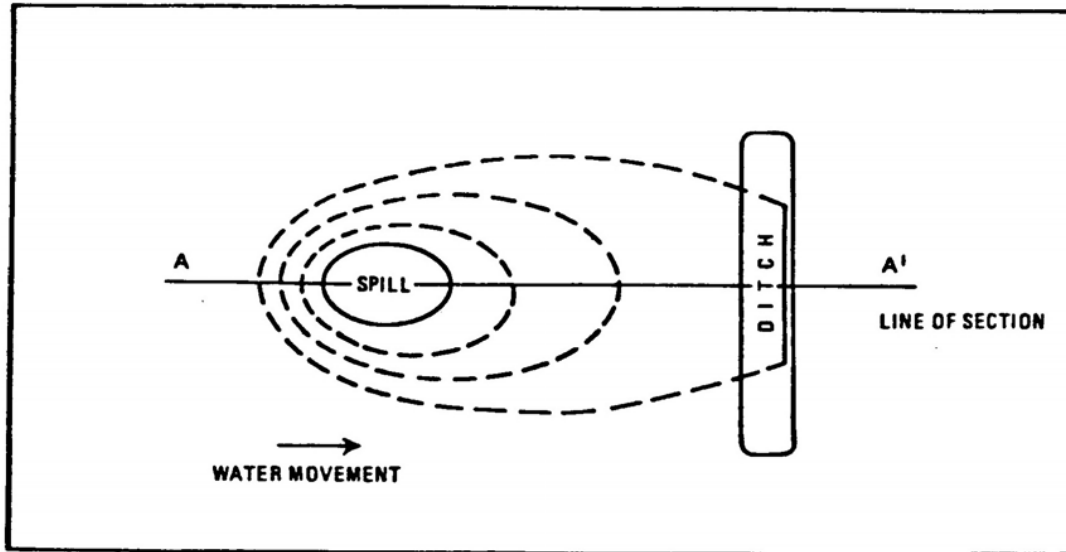
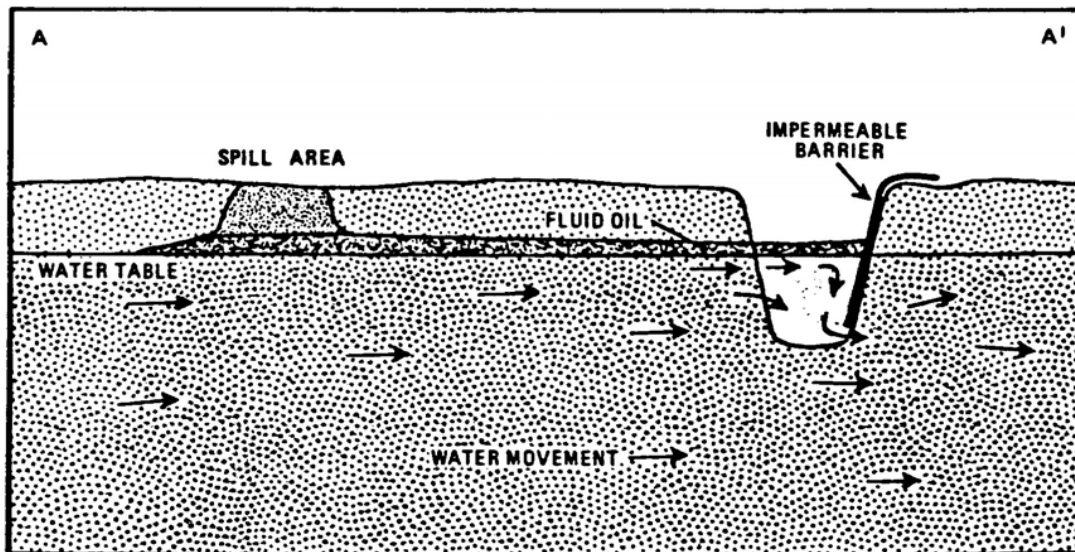

Figure 10-7: Oil on Water Table is Trapped in Cone of Depression Created by Drawdown of Pumping Well

This second method involves constructing a ditch across the entire front of the migrating body of oil and below the top of the water table. As the oil floats across the ditch, it is skimmed off the surface of the water (Figure 10-8). While this method is much less efficient than lowering the water table, it also produces much less fluid to be handled at the surface and is less costly. Under certain conditions, usually with a small spill, the method might be preferable. Its effectiveness depends on proper location of the ditch across the downstream end of the spill.



PLAN VIEW



CROSS SECTION

Figure 10-8: Oil Moving with Shallow Groundwater Intercepted by Ditch Constructed Across Migration Path

Because of the need for rapid action, the steps taken immediately after an oil spill on land generally precede any real assessment of the extent of the contamination. If groundwater seems likely to be affected, however, such data will be required. Thorough investigation increases the effectiveness of subsequent cleanup operations. The main purpose of the investigation is to determine the number, type, and optimum locations of recovery points.

The investigation normally is made by means of inspection holes and ditches, as described below. Inspection holes must extend several feet below the water table and should be designed to permit easy sampling and measuring of water levels. Grease, oil, or gasoline from machinery must be kept out of the holes to avoid erroneous data.

The best locations for inspection holes most often will be just beyond the surface limit of the spill. If a hole is found to be contaminated, another must be drilled farther out. Contaminated inspection wells, however, can double as recovery points. Once a series of inspection wells has isolated the contaminated area, the wells must be monitored periodically for later spread of the contaminant. The holes also may be useful in evaluating the development of the depression created in the water table by the recovery wells.

Ditches are an efficient method of removing oil if the water table is sufficiently shallow. Ditches more than 6 to 8 feet deep are usually impractical, but the limitation is imposed by the ditching equipment that is available and the extent to which the soil will support the walls of the ditch without caving. Ditches in unconsolidated soils must have gently sloping sides, and a large amount of soil must be removed relative to the depth of the ditch.

If the ditch is to be used as a withdrawal point to lower the water table, it should be at least 3 or 4 feet below the water table, and pumping capacity should be great enough to keep the water drawdown to the bottom of the ditch. Width is important only in that the ditch must be wide enough to accommodate the necessary pumps or other removal devices.

If the ditch is to be a collection point for skimming, its downstream wall should be lined with an impermeable material such as polyethylene film (Figure 10-9), which will block floating oil but permit water to pass below. Skimming must be continuous or collected oil will tend to move to the ends of the ditch and pass around the barrier.

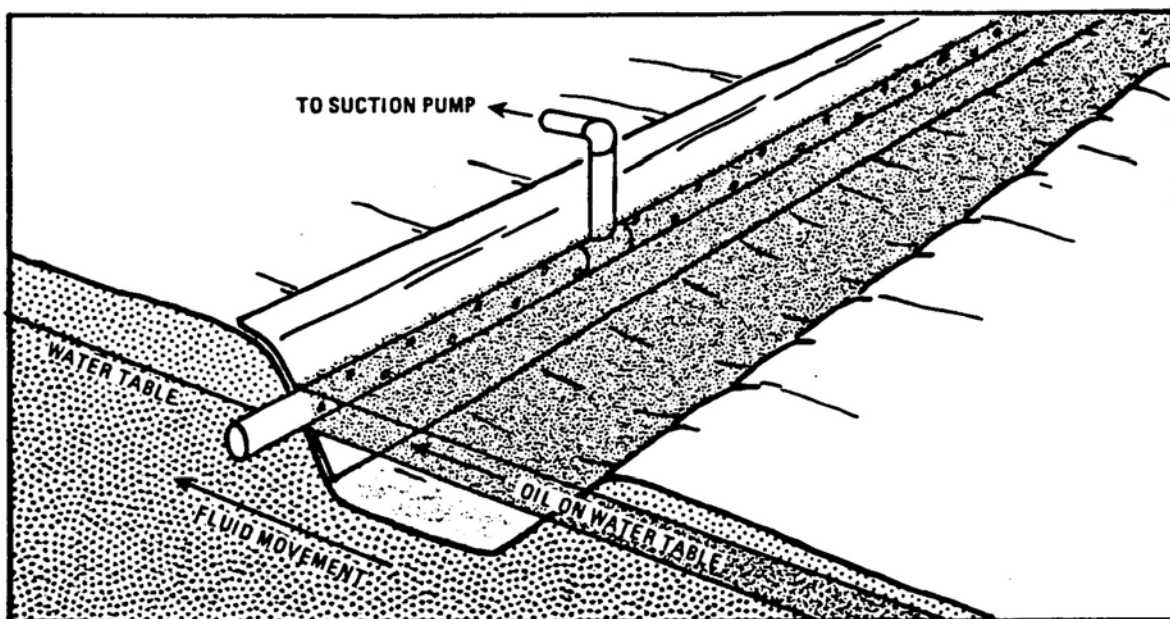

Figure 10-9: System for Skimming Water Surface in Ditches or Wells

Ditches need not be left open. One approach is to lay a string of perforated culvert pipe in the bottom and backfill the ditch with very porous material such as broken rock or gravel. Fluid enters the pipe through the perforations and can be removed through an opening left in the backfill for the purpose. Sometimes an intercepting ditch can be filled with straw to sorb the oil. The straw can be replaced periodically as it becomes saturated.

Fluid should be recovered from wells by the use of pumps. In the initial emergency, any kind of pump may be used, such as a boat-bailing pump or a hand-operated water well pump. As soon as possible, however, a standard well pump normally should be installed. Discharge capacities range from a few to about 100 gallons per minute, depending on pump size, casing diameter, and depth. Most such pumps require 5- or 6-inch casing. Submersible pumps, though highly efficient, should be used with caution since some types burn out quickly if operated dry. For depths to about 25 feet, gasoline-powered suction pumps are suitable for extended use and are widely available.

High-speed, rotary pumps should be avoided when pumping combinations of oil and water. They tend to encourage formation of oil-water emulsions that complicate separation at the surface.

The effects of well pumping from different depths are shown in Figures 10-10 and 10-11. The contaminated soil is relatively permeable, and the oil has migrated to the water table and spread there as a pancake. In Figure 10-10, Well 'A' does not extend into the pancake and pumping will recover a small and insignificant amount of the oil that is migrating to the water table. Well 'B' extends into the pancake and will produce oil from it initially, but the flow will fall quickly to a very low rate. The pancake is too thin to permit effective direct recovery. Well 'C' extends into the water table. It will produce water at first, but soon will begin to recover the floating oil as the fluid at the top of the water table is drawn down to the pump (Figure 10-11).

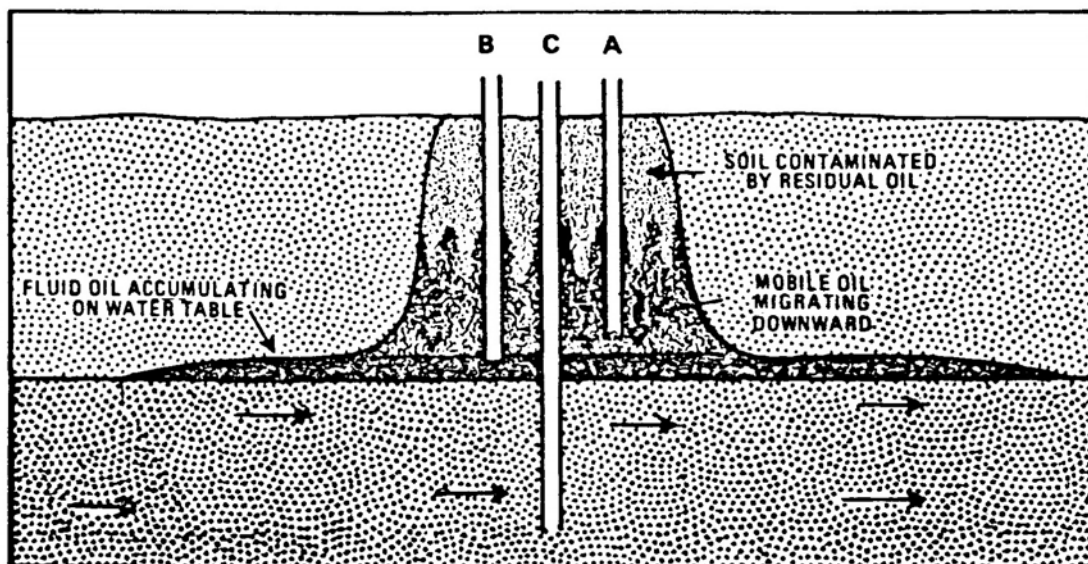

Figure 10-10: Typical Conditions During Latter Stage of Migration of Oil to Water Table

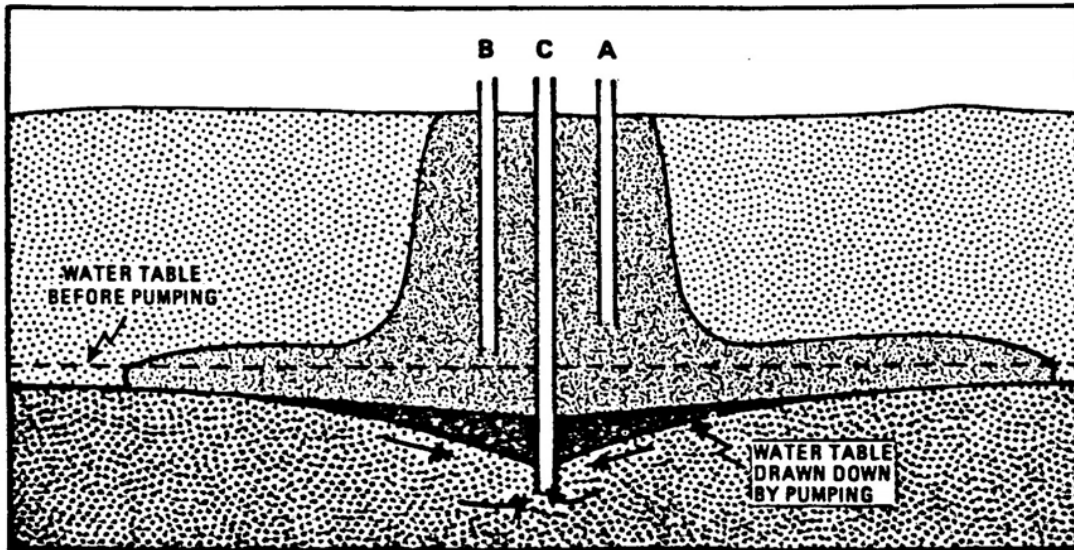

Figure 10-11: Effect on Water Table of Pumping from Well C

The water table is lowered at the withdrawal point of Well 'C' because water is removed faster than the soil's permeability allows it to be replenished. Both water and oil from the pancake are then drawn toward Well 'C' by the pressure differential. Water must be pumped from Well 'C' fast enough to create a depression cone that extends beyond the oil pancake and is deep enough to reverse the natural gradient of the water table. The oil will be prevented from flowing with groundwater away from the withdrawal point. With large spills, several wells may be required to depress the water table adequately over the necessary area.

Since permeability varies infinitely, no quantitative standards exist that apply to the depression-forming process in all areas. Figure 10-12 shows the development of an actual depression cone in an aquifer test near Saratoga Springs, N.Y. Precise selected data from the test are shown in Figure 10-13. The aquifer was 75 feet thick and consisted of fine to coarse, silty sand of moderately high permeability. It can be seen that the cone develops rapidly at first, and then spreads with decreasing speed.

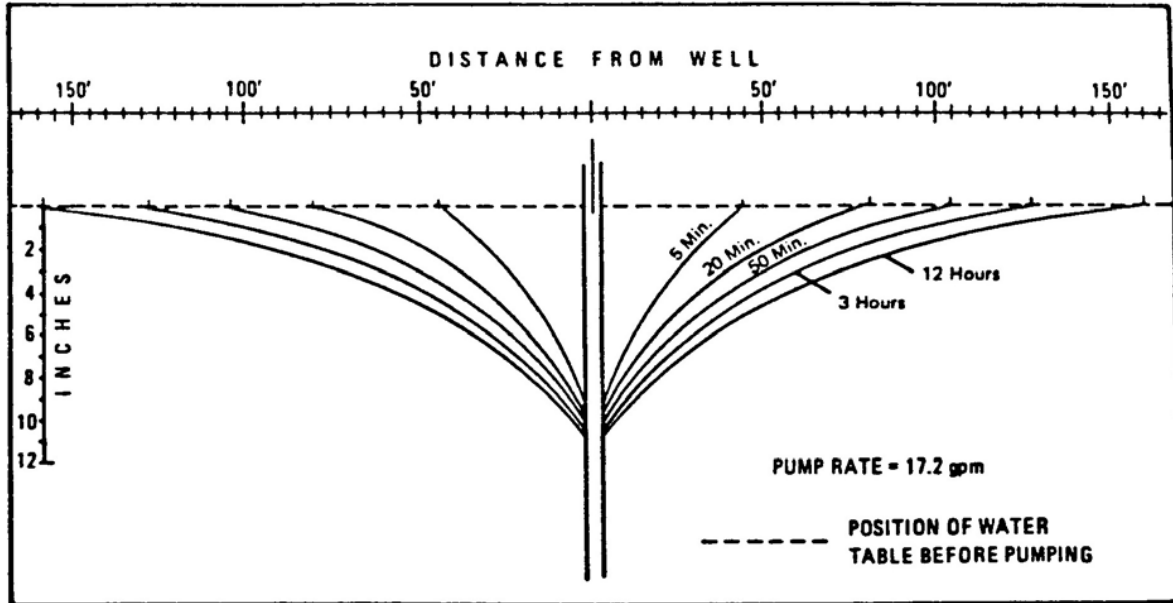

Figure 10-12: Diagrammatic Illustration of Development of a Cone of Depression Based on an Actual Aquifer Test
Scale Is Approximate. For Precise Data Plot, See Figure 10-13.

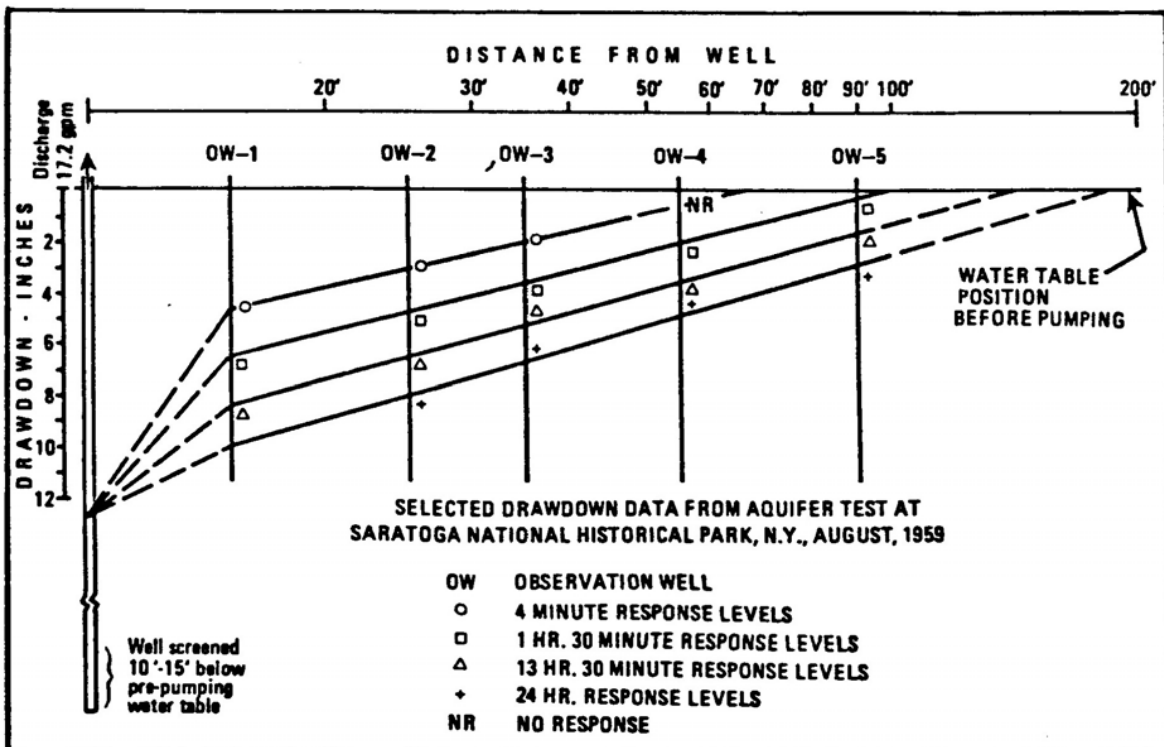

Figure 10-13: Selected Drawdown Data for an Aquifer Test

When enough data are available on an aquifer, the behavior of the depression cone some distance from the producing well can be calculated quite accurately. Within 100 to 200 feet of the well,

however, local heterogeneities in the aquifer make such calculations unreliable. A standard procedure is to sink two or three monitor wells in one or more straight lines away from the production well. By observing fluid levels in these wells, the exact time and amount of drawdown can be determined. From these data, further expansion of the depression cone can be predicted. Withdrawal rates should be adjusted, ideally, to maintain a cone large enough only to contain the oil. Creation of an unnecessarily large cone results in production of a large volume of uncontaminated water from beyond the area of the spill.

The average depression cone actually is much shallower than is suggested by Figure 10-14, in which horizontal distances are in feet and vertical distances in inches. If the water table is horizontal, a shallow depression normally will suffice to confine the floating oil. If the water table is inclined, which it usually is, the cone must be deep enough to reverse the resulting gradient. The point at which the reveal occurs is the water table "divide." If the oil is to be contained effectively, the divide must lie beyond the contaminated area.

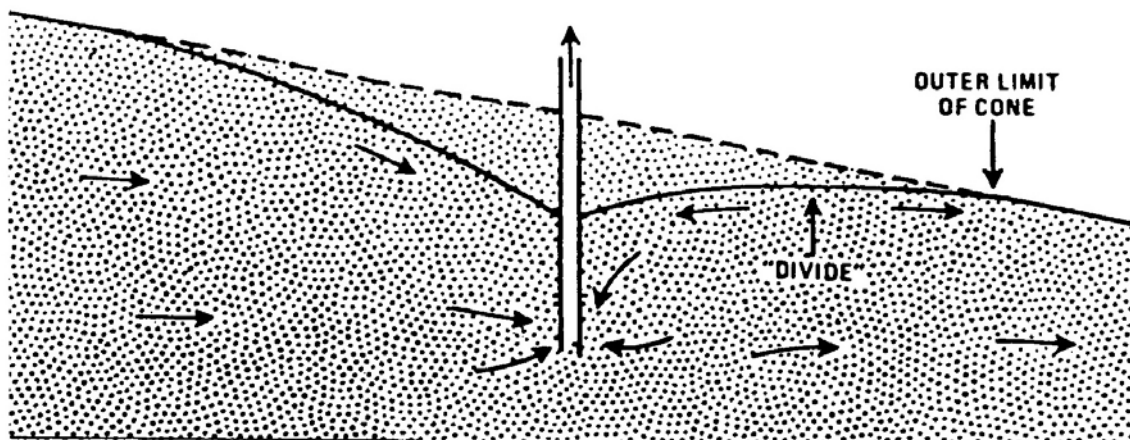

Figure 10-14: Drawdown Configuration of Well Pumping From Inclined Water Table
Fluid at the surface of the water table between the divide and outer limit of cone will not be trapped, but will move down gradient with the water.

The data of Figure 10-13 may not be precisely applicable to any other area. However, the data demonstrate that in a good aquifer a depression cone of considerable extent can probably be created in a matter of minutes or hours. This is enough time in most cases to install a recovery system before the oil can be carried out of reach by moving groundwater. The importance of the drawdown in relation to the gradient also must be kept in mind. The complexities described here and others not covered indicate the advisability of securing professional counsel.

Although a depression cone can be maintained by pumping from far below the surface of the water table, floating oil will not be recovered unless the surface is drawn down to the withdrawal point. It is, therefore, more effective to use two pumps instead of one. The larger pump is used to maintain the depression, while the smaller is arranged to pump the oil from the surface of the water (Figure 10-15). This method also tends to minimize the volume of fluid that must be separated at the surface.

Depending on the seriousness of the spill, pumping may be required for weeks or months. Ideally, pumping should be continued through several fluctuations of the water table and abandoned only after the contamination has been reduced to an acceptable level.

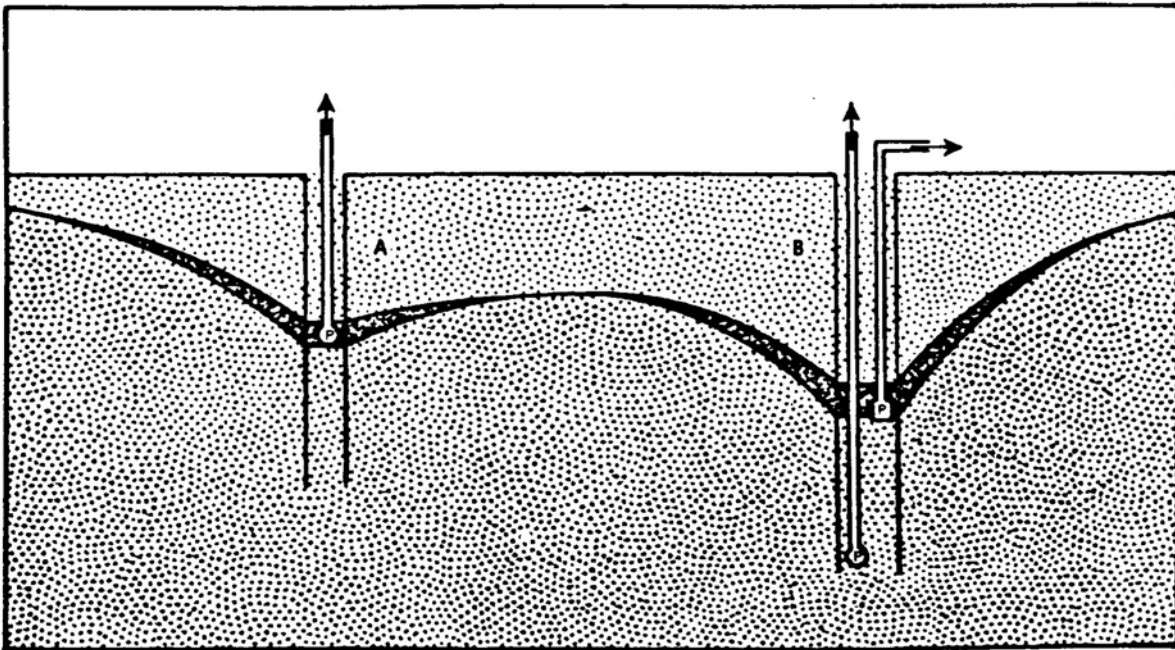

Figure 10-15: Well Pumping Using Two Pumps

Well A is maintaining depression and recovering oil in a single operation by drawing the fluid surface down to the pump level. Well B is maintaining depression by pumping clean water from below the water table. Floating oil is recovered by a suction pump at the fluid surface.

Recovery wells must be operated until the aquifer is no longer threatened by oil leached from the soil by percolating surface water. It may be possible to speed the leaching process by irrigating or flooding the soil above the contaminated zone, vastly increasing the volume of percolating water. Another approach that has been suggested is "miscible drive" by a harmless, water-insoluble oil, such as a purely paraffinic hydrocarbon.

This material, being miscible with the contaminant, would dissolve and extract it more quickly and completely than water. Left behind in the soil would be a harmless residue of the extracting oil to be consumed by natural processes. If such exotic processes are indicated, they should be planned carefully by qualified people and be acceptable to EPA and local pollution control authorities.

Water produced from an oil-contaminated reservoir may contain both fluid and dissolved petroleum products, which must be removed before the water is allowed to return to the groundwater. Oily fluids can be removed from the water by a gravity separator as discussed in Chapter 6 or by filtering.

10.7 GROUNDWATER ABSORPTION

In certain cases, it may be possible to absorb oil from groundwater using a recently developed method. This method uses oil absorbent polymers contained in “extraction socks” for retrieving oil from contaminated groundwater. The polymers must be of the true absorbent types that will not allow the absorbed oil to be released again once absorbed.

The socks are allowed to soak in the extraction well for a period of time (usually up to a week). When the socks are pulled out of the wells, only the water runs out, not the oil. This method could not be considered where groundwater is moving at an appreciable rate or for larger oil spills. Applicability might best be determined by the appropriate state authority.

10.8 SOIL WASHING

In suitable conditions, much oil can be recovered from loose, excavated soil by water washing with a high-pressure hose. The soil can be placed on the edge of a pit and washed into the pit with a fire hose. The oil floats to the surface of the resulting pond and can be skimmed off.

This procedure might also be used on-site. The contaminated soil would be excavated to form a pit, which then would be lined with an impermeable material such as plastic sheeting or clay. The soil could be washed back into the pit and the oil skimmed off. This approach would reduce trucking costs greatly.

CHAPTER 11 OIL DISPOSAL

11.1 RECLAMATION

Once an oil spill has been contained and harvested, the next step in completing the job is the disposal of the harvested material in a satisfactory and approved manner. This can be accomplished by using one or a combination of four basic disposal methods:

- Transport to oil reclamation centers
- Burning on site or at preselected burning pits, incinerators, or generating stations
- Burial on site or at approved distant sites
- Land spreading (land farming) at approved sites

Before determining which method of waste disposal should be used, local and state authorities should be consulted as to possible restrictions and special sites that may be available. In addition, any insulating oil that is to be disposed of should be tested for PCB concentration levels and should be disposed of accordingly. See EPA regulations 40 CFR 761 for further details of PCB disposal.

11.2 BURNING

In addition to state regulations, local governments have adopted regulations concerning open pit burning and incineration. Therefore, thorough knowledge of the local and state laws is a prerequisite to consideration of burning a recovered oil spill, whether debris-laden or not. In any event, permits must be obtained where required.

When possible, burning a recovered oil spill with accompanying debris near the site of cleanup is preferable to using distant sites because the recovered oil may be more volatile during the early stages and will burn more efficiently, with less ash or residue. Transportation costs and the risk of further damage to the environment also will be reduced from possible spillage along the route. Such on-site burning should be done sufficiently distant from any area that may be used for human, animal, or feed occupancy. Burning should be done only when and where prevailing winds will carry the smoke over the least inhabited area.

Burning any accumulation of oil or oily debris should be monitored at all times by personnel experienced in the behavior of open fires. Proper equipment should be at the burn sites to control the burn and to extinguish it if necessary. Local municipal or volunteer fire departments can provide the experienced personnel and equipment.

Open pit burning of free and relatively clean oil will normally leave very little residue; however, a debris-laden oil will not burn with such efficiency, leaving a significant amount of unburned trash along with some ash. This can be buried readily if a pit has been provided. Therefore, when oily debris is to be burned, a pit deep enough to hold the residue should be dug at a suitable location where burial can be accomplished by simply backfilling the hole.

11.3 INCINERATION

Incineration is the least polluting method of burning. It is, however, the most costly, not readily available, and requires preparation of the material into a form that can be fed into the incinerator. The cost of incineration, including transport to the incinerator, can be equal to or greater than all other costs of a cleanup operation. Therefore, before employing this system of disposal, carefully consider the alternatives. However, existing regulations may leave no other alternative. Some type of acceptable incineration is available in major metropolitan areas, but not usually in the rest of the nation. For remote areas, incineration would require long transport of the waste to such a site.

Incinerators vary in size and shape and will only receive material in a certain form. Therefore, if incineration is to be used, the material will have to be prepared in the proper form. Trash grinding machines that may be necessary may not be available.

11.4 GENERATING STATION DISPOSAL

An alternative to formal incineration, which is far less costly, is the burning of this oil-laden soil, debris, and sorbent material in coal generating station boilers. This material should be spread over the coal pile in thin layers to insure complete combustion. Care should be exercised, as discussed previously, to ensure that the size and shape of the materials being disposed of will not interfere with the operation of the conveyor system and pulverizers. This system of disposal should work particularly well in areas where lignite coal is the primary energy source.

11.5 BURIAL

Burial of recovered oil, debris laden or not, should not be done indiscriminately. In most states, burial must be at an approved site. Sanitary landfills, industrial disposal sites, and/or fly ash disposal sites will usually be able to handle small amounts of oil wastes. For burying large volumes of oil material, a special site may have to be selected, approved, and constructed—and that usually means great expense. In obtaining the use of specified burial sites, several factors must be considered.

For any burial site considered, oily waste disposal must be compatible with surrounding land uses. Residential, recreational, or industrial sites nearby may preclude the use of an otherwise ideal site. On the other hand, it might be less difficult to find an approved site near such areas. The use of prime agricultural or potential residential land cannot be automatically discounted, since it may be the only site that is finally approved.

An important factor in narrowing site choices is the suitability of the land for oily waste burial. The site's characteristics must not allow the buried oil to become a source of groundwater or surface water pollution (see Chapter 10). Soil conditions, subsurface hydrology, geologic structure, and surface topography all must be considered in deciding on the suitability of a site.

Soil conditions will determine the potential migration—upward, downward, or laterally—of the buried oil. A loose, unconsolidated sand or gravel bed in a potential site area would not be

suitable, especially in high rainfall areas. Oil can migrate in any direction in this type of soil. A loosely packed backfill can permit upward percolation and surface exposure. Heavy rainfall would accentuate the rise to the surface. Oil in earthen pits has been known to migrate upward by either capillary action or by a rise in water level. This oil can contaminate the surface area of the pit, and, to a lesser degree, the soil a good distance from the pit. This could condemn the use of that portion of land for many years to come.

Obviously, selection of a suitable site for burial of oily wastes requires specialized knowledge, which is best obtained from engineers and scientists familiar with a particular area.

Once the suitability of potential sites has been determined, landowner, public, and/or governmental agency opposition to the use of the site for oily waste burial will affect whether the site selected is in a rural, agricultural, or a higher density area. Selection and approval of a burial site ultimately may be made after a series of compromises among the various opposing interests.

11.6 LAND SPREADING (LAND FARMING)

This is the term given to disposal of oil or oily debris by mixing it with soil to promote aerobic degradation. Land farming is the most sophisticated method of disposing of oily waste or debris. Also, it is probably the best from an overall environmental aspect. The microbes “eat” the oil and use it for their energy, with CO₂ as their waste product. When the oil is depleted, the microbes die out and all that is left is clean soil. Many variables must be carefully reviewed before undertaking a land farm operation.

Site selection is the first prerequisite. The larger the volume of oil for disposal or the greater the oil concentration, the more land area that will be needed. Depth of suitable soil plays a role. The deeper the farming, the less surface area is required.

The type of oily waste or oily debris, along with the physical and chemical properties of the oil, must be known to determine the soil’s suitability and compatibility with the oil. Major errors or oversights here could result in causing damage instead of alleviating a problem.

Once compatibility of the oily debris and soil has been established by local experts, preparing the soil and stockpiling the waste for burial can proceed. This requires proper and adequate equipment as well as experienced operators.

Preparing the soil is not an easy task. It is recommended that brush and rocks 6 inches or more in diameter be removed, as they inhibit proper soil/oil mixing. The site should be leveled to a 1 percent or 2 percent grade. The soil should be scarified 1 to 2 inches in a cold climate, or 3 to 4 inches in warmer climates. It may be necessary to add soil nutrients to support the growth of hydrocarbon-consuming microbes.

The oily waste of debris must be prepared and stockpiled near the land farm site. It is recommended that it be spread over the scarified soil to a thickness of no more than 5 inches. Rototillers, harrows, or discs can be used to mix the oily debris and soil to depths of 4 to 5 inches. Tilling the mixed elements then can follow, using normal agricultural procedures. It may

be necessary to periodically remix the soil and debris to aerate the material and induce biodegradation. Some sites have been known to require plowing every 2 to 4 months. Once no oil is visible after remixing, the process can be considered complete and successful. Revegetation can follow.

Land farming may, indeed, be the answer for disposal of certain oily wastes and debris. It should not be undertaken without guidance from those experienced in the process, approval from regulatory agencies (State or Federal) and, finally, with the aid of a specialist knowledgeable about local soils and conditions.

Appendix A

EPA REGIONAL OFFICES

Environmental Protection Agency (EPA) (Website www.epa.gov)

Region 1

Environmental Protection Agency
1 Congress Street, Suite 1100
Boston, MA 02114-2023
Phone: 888-372-7341

Region 2

Environmental Protection Agency
290 Broadway
New York, NY 10007-1866
Phone: 212-637-3660

Region 3

Environmental Protection Agency
1650 Arch Street (3PM52)
Philadelphia, PA 19103-2029
Phone: 215-814-5000

Region 4

Environmental Protection Agency
Sam Nunn Atlanta Federal Center
61 Forsyth Street, SW
Atlanta, GA 30303-3104
Phone: 404-562-9900

Region 5

Environmental Protection Agency
77 W Jackson Blvd
Chicago, IL 60604
Phone: 312-353-2000

Region 6

Environmental Protection Agency
1445 Ross Avenue
Suite 1200
Dallas, TX 75202
Phone: 214-665-6444

Region 7

Environmental Protection Agency
Office of External Program
901 N 5th Street
Kansas City, KS 66101
Phone: 913-551-7003

Region 8

US EPA Region 8
80C-EISC
1595 Wynkoop St.
Denver, CO 80202-1129
Phone: 303-312-6312

Region 9

Environmental Protection Agency
75 Hawthorne Street
San Francisco, CA 94105
Phone: 415-947-8000

Region 10

US EPA Region 10
1200 Sixth Avenue Suite 900
Seattle, WA 98101
Phone: 206-553-1200

REGIONS

- 4 – Alabama
- 10 – Alaska
- 9 – Arizona
- 6 – Arkansas
- 9 – California
- 8 – Colorado
- 1 – Connecticut
- 3 – Delaware
- 3 – D. C.
- 4 – Florida
- 4 – Georgia
- 9 – Hawaii
- 10 – Idaho
- 5 – Illinois
- 5 – Indiana
- 7 – Iowa
- 7 – Kansas
- 4 – Kentucky
- 6 – Louisiana

REGIONS

- 1 – Maine
- 3 – Maryland
- 1 – Massachusetts
- 5 – Michigan
- 5 – Minnesota
- 4 – Mississippi
- 7 – Missouri
- 8 – Montana
- 7 – Nebraska
- 9 – Nevada
- 1 – New Hampshire
- 2 – New Jersey
- 6 – New Mexico
- 2 – New York
- 4 – North Carolina
- 8 – North Dakota
- 5 – Ohio
- 6 – Oklahoma
- 10 – Oregon

REGIONS

- 3 – Pennsylvania
- 1 – Rhode Island
- 4 – South Carolina
- 8 – South Dakota
- 4 – Tennessee
- 6 – Texas
- 8 – Utah
- 1 – Vermont
- 3 – Virginia
- 10 – Washington
- 3 – West Virginia
- 5 – Wisconsin
- 8 – Wyoming
- 9 – American Samoa
- 9 – Guam
- 2 – Puerto Rico
- 2 – Virgin Islands

APPENDIX B

Normal Precipitation Tables

From "Comparative Climatic Data for United States Through 2000"
National Oceanic and Atmospheric Administration
National Climatic Data Center
Asheville, North Carolina

Normal Monthly Precipitation (Inches)

Normals 1971–2000	Yrs	Jan.	Feb.	Mar.	Apr.	May	June	July	Aug.	Sep.	Oct.	Nov.	Dec.	Ann.
Birmingham Airport, Ala.	30	5.45	4.21	6.10	4.67	4.83	3.78	5.09	3.48	4.05	3.23	4.63	4.47	53.99
Huntsville, Ala.	30	5.52	4.95	6.68	4.54	5.24	4.22	4.40	3.32	4.29	3.54	5.22	5.59	57.51
Mobile, Ala.	30	5.75	5.10	7.20	5.06	6.10	5.01	6.54	6.20	6.01	3.25	5.41	4.66	66.29
Montgomery, Ala.	30	5.04	5.45	6.39	4.38	4.14	4.13	5.31	3.63	4.22	2.58	4.53	4.97	54.77
Anchorage, Alaska	30	0.68	0.74	0.65	0.52	0.69	1.06	1.70	2.93	2.87	2.08	1.09	1.05	16.08
Annette, Alaska	30	9.67	8.05	7.96	7.37	5.73	4.72	4.26	6.12	9.49	13.86	12.21	11.39	100.83
Barrow, Alaska	30	0.12	0.12	0.09	0.12	0.12	0.32	0.87	1.04	0.69	0.39	0.16	0.12	4.16
Bethel, Alaska	30	0.62	0.51	0.67	0.65	0.85	1.60	2.03	3.02	2.31	1.43	1.37	1.12	16.18
Bettles, Alaska	30	0.84	0.61	0.55	0.38	0.85	1.43	2.10	2.54	1.82	1.08	0.90	0.87	13.97
Big Delta, Alaska	30	0.34	0.41	0.22	0.20	0.77	2.38	2.77	2.11	1.03	0.73	0.59	0.39	11.94
Cold Bay, Alaska	30	3.08	2.59	2.48	2.30	2.65	2.89	2.53	3.59	4.51	4.54	4.79	4.33	40.28
Fairbanks, Alaska	30	0.56	0.36	0.28	0.21	0.60	1.40	1.73	1.74	1.12	0.92	0.68	0.74	10.34
Gulkana, Alaska	30	0.45	0.52	0.36	0.22	0.59	1.54	1.82	1.80	1.44	1.02	0.67	0.97	11.40
Homer, Alaska	30	2.61	2.04	1.82	1.21	1.07	0.96	1.45	2.28	3.37	2.77	2.87	3.00	25.45
Juneau, Alaska	30	4.81	4.02	3.51	2.96	3.48	3.36	4.14	5.37	7.54	8.30	5.43	5.41	58.33
King Salmon, Alaska	30	1.03	0.72	0.79	0.94	1.35	1.70	2.15	2.89	2.81	2.09	1.54	1.39	19.41
Kodiak, Alaska	30	8.17	5.72	5.22	5.48	6.31	5.38	4.12	4.48	7.84	8.36	6.63	7.64	75.35
Kotzebue, Alaska	30	0.55	0.42	0.38	0.41	0.33	0.57	1.43	2.00	1.70	0.95	0.71	0.60	10.05
McGrath, Alaska	30	1.04	0.74	0.81	0.66	1.02	1.45	2.32	2.75	2.36	1.46	1.46	1.44	17.51
Nome, Alaska	30	0.92	0.75	0.60	0.65	0.74	1.14	2.15	3.23	2.51	1.58	1.28	1.01	16.56
St. Paul Island, Alaska	30	1.74	1.25	1.12	1.12	1.21	1.41	1.91	2.96	2.79	2.70	2.87	2.13	23.21
Talkeetna, Alaska	30	1.45	1.28	1.26	1.22	1.64	2.41	3.24	4.53	4.35	3.06	1.78	1.96	28.18
Unalakleet, Alaska	30	0.40	0.31	0.39	0.35	0.55	1.25	2.15	2.92	2.10	0.89	0.66	0.47	12.44
Valdez, Alaska	30	6.02	5.53	4.49	3.55	3.08	3.01	3.84	6.62	9.59	8.58	5.51	7.59	67.41
Yakutat, Alaska	30	13.18	10.99	11.41	10.80	9.78	7.17	7.88	13.27	20.88	24.00	15.17	15.85	160.38
Flagstaff, Ariz.	30	2.18	2.56	2.62	1.29	0.80	0.43	2.40	2.89	2.12	1.93	1.86	1.83	22.91
Phoenix, Ariz.	30	0.83	0.77	1.07	0.25	0.16	0.09	0.99	0.94	0.75	0.79	0.73	0.92	8.29
Tucson, Ariz.	30	0.99	0.88	0.81	0.28	0.24	0.24	2.07	2.30	1.45	1.21	0.67	1.03	12.17
Winslow, Ariz.	30	0.46	0.53	0.61	0.27	0.36	0.30	1.18	1.31	1.02	0.90	0.55	0.54	8.03
Yuma, Ariz.	30	0.38	0.28	0.27	0.09	0.05	0.02	0.23	0.61	0.26	0.26	0.14	0.42	3.01

Normal Monthly Precipitation (Inches)

Normals 1971–2000	Yrs	Jan.	Feb.	Mar.	Apr.	May	June	July	Aug.	Sept.	Oct.	Nov.	Dec.	Ann.
Fort Smith, Ark.	30	2.37	2.59	3.94	3.91	5.29	4.28	3.19	2.56	3.61	3.94	4.80	3.39	43.87
Little Rock, Ark.	30	3.61	3.33	4.88	5.47	5.05	3.95	3.31	2.93	3.71	4.25	5.73	4.71	50.93
North Little Rock, Ark.	30	3.37	3.27	4.88	5.03	5.40	3.51	3.15	2.97	3.53	3.81	5.74	4.53	49.19
Bakersfield, Calif.	30	1.18	1.21	1.41	0.45	0.24	0.12	0.00	0.08	0.15	0.30	0.59	0.76	6.49
Bishop, Calif.	30	0.88	0.97	0.62	0.24	0.26	0.21	0.17	0.13	0.28	0.20	0.44	0.62	5.02
Eureka, Calif..	30	5.97	5.51	5.55	2.91	1.62	0.65	0.16	0.38	0.86	2.36	5.78	6.35	38.10
Fresno, Calif.	30	2.16	2.12	2.20	0.76	0.39	0.23	0.01	0.01	0.26	0.65	1.10	1.34	11.23
Long Beach, Calif.	30	2.95	3.01	2.43	0.60	0.23	0.08	0.02	0.10	0.24	0.40	1.12	1.76	12.94
Los Angeles Airport, Calif.	30	2.98	3.11	2.40	0.63	0.24	0.08	0.03	0.14	0.26	0.36	1.13	1.79	13.15
Los Angeles C.O., Calif.	30	3.33	3.68	3.14	0.83	0.31	0.06	0.01	0.13	0.32	0.37	1.05	1.91	15.14
Mount Shasta, Calif.	30	7.06	6.45	5.81	2.65	1.87	0.99	0.39	0.43	0.87	2.21	5.08	5.35	39.16
Redding, Calif.	30	6.50	5.49	5.15	2.40	1.66	0.69	0.05	0.22	0.48	2.18	4.03	4.67	33.52
Sacramento, Calif.	30	3.84	3.54	2.80	1.02	0.53	0.20	0.05	0.06	0.36	0.89	2.19	2.45	17.93
San Diego, Calif.	30	2.28	2.04	2.26	0.75	0.20	0.09	0.03	0.09	0.21	0.44	1.07	1.31	10.77
San Francisco Airport, Calif.	30	4.45	4.01	3.26	1.17	0.38	0.11	0.03	0.07	0.20	1.04	2.49	2.89	20.11
San Francisco C.O., Calif.	30	4.72	4.15	3.40	1.25	0.54	0.13	0.04	0.09	0.28	1.19	3.31	3.18	22.28
Santa Barbara, Calif.	30	3.57	4.28	3.51	0.63	0.23	0.05	0.03	0.11	0.42	0.52	1.32	2.26	16.93
Santa Maria, Calif.	30	2.64	3.23	2.94	0.91	0.32	0.05	0.03	0.05	0.31	0.45	1.24	1.84	14.01
Stockton, Calif.	30	2.71	2.46	2.28	0.96	0.50	0.09	0.05	0.05	0.33	0.82	1.77	1.82	13.84
Alamosa, Colo.	30	0.25	0.21	0.46	0.54	0.70	0.59	0.94	1.19	0.89	0.67	0.48	0.33	7.25
Colorado Springs, Colo.	30	0.28	0.35	1.06	1.62	2.39	2.34	2.85	3.48	1.23	0.86	0.52	0.42	17.40
Denver, Colo.	30	0.51	0.49	1.28	1.93	2.32	1.56	2.16	1.82	1.14	0.99	0.98	0.63	15.81
Grand Junction, Colo.	30	0.60	0.50	1.00	0.86	0.98	0.41	0.66	0.84	0.91	1.00	0.71	0.52	8.99
Pueblo, Colo.	30	0.33	0.26	0.97	1.25	1.49	1.33	2.04	2.27	0.84	0.64	0.58	0.39	12.39
Bridgeport, Conn.	30	3.73	2.92	4.15	3.99	4.03	3.57	3.77	3.75	3.58	3.54	3.65	3.47	44.15
Hartford, Conn.	30	3.84	2.96	3.88	3.86	4.39	3.85	3.67	3.98	4.13	3.94	4.06	3.60	46.16
Wilmington, Del.	30	3.43	2.81	3.97	3.39	4.15	3.59	4.28	3.51	4.01	3.08	3.19	3.40	42.81
Washington Dulles Ap, D.C.	30	3.05	2.77	3.55	3.22	4.22	4.07	3.57	3.78	3.82	3.37	3.31	3.07	41.80
Washington Nat'l Ap, D.C.	30	3.21	2.63	3.60	2.77	3.82	3.13	3.66	3.44	3.79	3.22	3.03	3.05	39.35
Apalachicola, Fla.	30	4.87	3.76	4.95	3.00	2.62	4.30	7.31	7.29	7.10	4.18	3.62	3.51	56.51

Normal Monthly Precipitation (Inches)

Normals 1971–2000	Yrs	Jan.	Feb.	Mar.	Apr.	May	June	July	Aug.	Sep.	Oct.	Nov.	Dec.	Ann.
Daytona Beach, Fla.	30	3.13	2.74	3.84	2.54	3.26	5.69	5.17	6.09	6.61	4.48	3.03	2.71	49.29
Fort Myers, Fla.	30	2.23	2.10	2.74	1.67	3.42	9.77	8.98	9.54	7.86	2.59	1.71	1.58	54.19
Gainesville, Fla.	30	3.51	3.39	4.26	2.86	3.23	6.78	6.10	6.63	4.37	2.50	2.17	2.56	48.36
Jacksonville, Fla.	30	3.69	3.15	3.93	3.14	3.48	5.37	5.97	6.87	7.90	3.86	2.34	2.64	52.34
Key West, Fla.	30	2.22	1.51	1.86	2.06	3.48	4.57	3.27	5.40	5.45	4.34	2.64	2.14	38.94
Miami, Fla.	30	1.88	2.07	2.56	3.36	5.52	8.54	5.79	8.63	8.38	6.19	3.43	2.18	58.53
Orlando, Fla.	30	2.43	2.35	3.54	2.42	3.74	7.35	7.15	6.25	5.76	2.73	2.32	2.31	48.35
Pensacola, Fla.	30	5.34	4.68	6.40	3.89	4.40	6.39	8.02	6.85	5.75	4.13	4.46	3.97	64.28
Tallahassee, Fla.	30	5.36	4.63	6.47	3.59	4.95	6.92	8.04	7.03	5.01	3.25	3.86	4.10	63.21
Tampa, Fla.	30	2.27	2.67	2.84	1.80	2.85	5.50	6.49	7.60	6.54	2.29	1.62	2.30	44.77
Vero Beach, Fla.	30	2.89	2.45	4.20	2.88	3.80	6.03	6.53	6.04	6.84	5.04	3.04	2.19	51.93
West Palm Beach, Fla.	30	3.75	2.55	3.68	3.57	5.39	7.58	5.97	6.65	8.10	5.46	5.55	3.14	61.39
Athens, Ga.	30	4.69	4.39	4.99	3.35	3.86	3.94	4.41	3.78	3.53	3.47	3.71	3.71	47.83
Atlanta, Ga.	30	5.02	4.68	5.38	3.62	3.95	3.63	5.12	3.67	4.09	3.11	4.10	3.82	50.20
Augusta, Ga.	30	4.50	4.11	4.61	2.94	3.07	4.19	4.07	4.48	3.59	3.20	2.68	3.14	44.58
Columbus, Ga.	30	4.78	4.48	5.75	3.84	3.62	3.51	5.04	3.78	3.07	2.33	3.97	4.40	48.57
Macon, Ga.	30	5.00	4.55	4.89	3.14	2.98	3.54	4.32	3.79	3.26	2.37	3.22	3.93	45.00
Savannah, Ga.	30	3.95	2.92	3.64	3.32	3.61	5.49	6.04	7.20	5.08	3.12	2.40	2.81	49.58
Hilo, Hawaii	30	9.74	8.86	14.35	12.54	8.07	7.36	10.71	9.78	9.14	9.64	15.58	10.50	126.27
Honolulu, Hawaii	30	2.73	2.35	1.89	1.11	0.78	0.43	0.50	0.46	0.74	2.18	2.26	2.85	18.29
Kahului, Hawaii	30	3.74	2.36	2.35	1.75	0.66	0.23	0.49	0.53	0.39	1.05	2.17	3.08	18.80
Lihue, Hawaii	30	4.59	3.26	3.58	3.00	2.87	1.82	2.12	1.91	2.69	4.25	4.70	4.78	39.57
Boise, Idaho	30	1.39	1.14	1.41	1.27	1.27	0.74	0.39	0.30	0.76	0.76	1.38	1.38	12.19
Lewiston, Idaho	30	1.14	0.95	1.12	1.30	1.56	1.16	0.72	0.75	0.80	0.96	1.21	1.05	12.74
Pocatello, Idaho	30	1.14	1.01	1.38	1.18	1.51	0.91	0.70	0.66	0.89	0.97	1.13	1.10	12.58
Chicago, Ill.	30	1.75	1.63	2.65	3.68	3.38	3.63	3.51	4.62	3.27	2.71	3.01	2.43	36.27
Moline, Ill.	30	1.58	1.51	2.92	3.82	4.25	4.63	4.03	4.41	3.16	2.80	2.73	2.20	38.04
Peoria, Ill.	30	1.50	1.67	2.83	3.56	4.17	3.84	4.02	3.16	3.12	2.76	2.99	2.40	36.03
Rockford, Ill.	30	1.41	1.34	2.39	3.62	4.02	4.80	4.10	4.21	3.47	2.57	2.63	2.06	36.63
Springfield, Ill.	30	1.62	1.80	3.15	3.36	4.06	3.77	3.53	3.41	2.83	2.62	2.87	2.54	35.56

Normal Monthly Precipitation (Inches)

Normals 1971-2000	Yrs	Jan.	Feb.	Mar.	Apr.	May	June	July	Aug.	Sep.	Oct.	Nov.	Dec.	Ann.
Evansville, Ind.	30	2.91	3.10	4.29	4.48	5.01	4.10	3.75	3.14	2.99	2.78	4.18	3.54	44.27
Fort Wayne, Ind.	30	2.05	1.94	2.86	3.54	3.75	4.04	3.58	3.60	2.81	2.63	2.98	2.77	36.55
Indianapolis, Ind.	30	2.48	2.41	3.44	3.61	4.35	4.13	4.42	3.82	2.88	2.76	3.61	3.03	40.95
South Bend, Ind.	30	2.27	1.98	2.89	3.62	3.50	4.19	3.73	3.98	3.79	3.27	3.39	3.09	39.70
Des Moines, Iowa	30	1.03	1.19	2.21	3.58	4.25	4.57	4.18	4.51	3.15	2.62	2.10	1.33	34.72
Dubuque, Iowa	30	1.28	1.42	2.57	3.49	4.12	4.08	3.73	4.59	3.56	2.50	2.49	1.69	35.52
Sioux City, Iowa	30	0.59	0.62	2.00	2.75	3.75	3.61	3.30	2.90	2.42	1.99	1.40	0.66	25.99
Waterloo, Iowa	30	0.84	1.05	2.13	3.23	4.15	4.82	4.20	4.08	2.95	2.49	2.10	1.11	33.15
Concordia, Kan.	30	0.66	0.73	2.35	2.45	4.20	3.95	4.20	3.24	2.50	1.84	1.45	0.86	28.43
Dodge City, Kan.	30	0.62	0.66	1.84	2.25	3.00	3.15	3.17	2.73	1.70	1.45	1.01	0.77	22.35
Goodland, Kan.	30	0.43	0.44	1.20	1.51	3.46	3.30	3.54	2.49	1.12	1.05	0.82	0.40	19.76
Topeka, Kan.	30	0.95	1.18	2.56	3.14	4.86	4.88	3.83	3.81	3.71	2.99	2.31	1.42	35.64
Wichita, Kan.	30	0.84	1.02	2.71	2.57	4.16	4.25	3.31	2.94	2.96	2.45	1.82	1.35	30.38
Greater Cincinnati Airport	30	2.92	2.75	3.90	3.96	4.59	4.42	3.75	3.79	2.82	2.96	3.46	3.28	42.60
Jackson, Ky.	30	3.56	3.68	4.38	3.79	5.16	4.67	4.59	4.13	3.77	3.18	4.20	4.27	49.38
Lexington, Ky.	30	3.34	3.27	4.41	3.67	4.78	4.58	4.80	3.77	3.11	2.70	3.44	4.03	45.91
Louisville, Ky.	30	3.28	3.25	4.41	3.91	4.88	3.76	4.30	3.41	3.05	2.79	3.80	3.69	44.54
Paducah, Ky.	30	3.47	3.93	4.27	4.95	4.75	4.51	4.45	2.99	3.56	3.45	4.53	4.38	49.24
Baton Rouge, La.	30	6.19	5.10	5.07	5.56	5.34	5.33	5.96	5.86	4.84	3.81	4.76	5.26	63.08
Lake Charles, La.	30	5.52	3.28	3.54	3.64	6.06	6.07	5.12	4.85	5.95	3.94	4.61	4.60	57.19
New Orleans, La.	30	5.87	5.47	5.24	5.02	4.62	6.83	6.20	6.15	5.55	3.05	5.09	5.07	64.16
Shreveport, La.	30	4.60	4.21	4.18	4.42	5.25	5.05	3.99	2.71	3.21	4.45	4.68	4.55	51.30
Caribou, Maine	30	2.97	2.06	2.57	2.64	3.27	3.31	3.89	4.15	3.27	2.99	3.12	3.19	37.44
Portland, Maine	30	4.09	3.14	4.14	4.26	3.82	3.28	3.32	3.05	3.37	4.40	4.72	4.24	45.83
Baltimore, Md.	30	3.47	3.02	3.93	3.00	3.89	3.43	3.85	3.74	3.98	3.16	3.12	3.35	41.94
Blue Hill, Mass.	30	4.78	4.06	4.79	4.32	3.79	3.93	3.74	4.06	4.13	4.42	4.64	4.56	51.22
Boston, Mass.	30	3.92	3.30	3.85	3.60	3.24	3.22	3.06	3.37	3.47	3.79	3.98	3.73	42.53
Worcester, Mass.	30	4.07	3.10	4.23	3.92	4.35	4.02	4.19	4.09	4.27	4.67	4.34	3.80	49.05
Alpena, Mich.	30	1.76	1.35	2.13	2.31	2.61	2.53	3.17	3.50	2.80	2.33	2.08	1.83	28.40
Detroit, Mich.	30	1.91	1.88	2.52	3.05	3.05	3.55	3.16	3.10	3.27	2.23	2.66	2.51	32.89

Normal Monthly Precipitation (Inches)

Normals 1971–2000	Yrs	Jan.	Feb.	Mar.	Apr.	May	June	July	Aug.	Sep.	Oct.	Nov.	Dec.	Ann.
Flint, Mich.	30	1.57	1.35	2.22	3.13	2.74	3.07	3.17	3.43	3.76	2.34	2.65	2.18	31.61
Grand Rapids, Mich.	30	2.03	1.53	2.59	3.48	3.35	3.67	3.56	3.78	4.28	2.80	3.35	2.70	37.13
Houghton Lake, Mich.	30	1.61	1.25	2.05	2.29	2.57	2.93	2.75	3.72	3.11	2.26	2.14	1.75	28.43
Lansing, Mich.	30	1.61	1.45	2.33	3.09	2.71	3.60	2.68	3.46	3.48	2.29	2.66	2.17	31.53
Marquette, Mich.	30	2.60	1.85	3.13	2.79	3.07	3.21	3.01	3.55	3.74	3.66	3.27	2.43	36.31
Muskegon, Mich.	30	2.22	1.58	2.36	2.91	2.95	2.58	2.32	3.77	3.52	2.80	3.23	2.64	32.88
Sault Ste. Marie, Mich.	30	2.64	1.60	2.41	2.57	2.50	3.00	3.14	3.47	3.71	3.32	3.40	2.91	34.67
Duluth, Minn.	30	1.12	0.83	1.69	2.09	2.95	4.25	4.20	4.22	4.13	2.46	2.12	0.94	31.00
International Falls, Minn.	30	0.84	0.64	0.96	1.38	2.55	3.98	3.37	3.14	3.03	1.98	1.36	0.70	23.93
Minneapolis-St.Paul, Minn.	30	1.04	0.79	1.86	2.31	3.24	4.34	4.04	4.05	2.69	2.11	1.94	1.00	29.41
Rochester, Minn.	30	0.94	0.75	1.88	3.01	3.53	4.00	4.61	4.33	3.12	2.20	2.01	1.02	31.40
Saint Cloud, Minn.	30	0.76	0.59	1.50	2.13	2.97	4.51	3.34	3.93	2.93	2.24	1.54	0.69	27.13
Jackson, Miss.	30	5.67	4.50	5.74	5.98	4.86	3.82	4.69	3.66	3.23	3.42	5.04	5.34	55.95
Meridian, Miss.	30	5.92	5.35	6.93	5.62	4.87	3.99	5.45	3.34	3.64	3.28	4.95	5.31	58.65
Tupelo, Miss.	30	5.14	4.68	6.30	4.94	5.80	4.82	3.65	2.67	3.35	3.38	5.01	6.12	55.86
Columbia, Mo.	30	1.73	2.20	3.21	4.16	4.87	4.02	3.80	3.75	3.42	3.18	3.47	2.47	40.28
Kansas City, Mo.	30	1.15	1.31	2.44	3.38	5.39	4.44	4.42	3.54	4.64	3.33	2.30	1.64	37.98
St. Louis, Mo.	30	2.14	2.28	3.60	3.69	4.11	3.76	3.90	2.98	2.96	2.76	3.71	2.86	38.75
Springfield, Mo.	30	2.11	2.28	3.82	4.31	4.57	5.02	3.56	3.37	4.83	3.47	4.46	3.17	44.97
Billings, Mont.	30	0.81	0.57	1.12	1.74	2.48	1.89	1.28	0.85	1.34	1.26	0.75	0.67	14.77
Glasgow, Mont.	30	0.35	0.26	0.47	0.75	1.72	2.20	1.78	1.25	0.98	0.71	0.39	0.37	11.23
Great Falls, Mont.	30	0.68	0.51	1.01	1.40	2.53	2.24	1.45	1.65	1.23	0.93	0.59	0.67	14.89
Havre, Mont.	30	0.47	0.36	0.70	0.87	1.84	1.90	1.51	1.20	1.03	0.62	0.45	0.51	11.46
Helena, Mont.	30	0.52	0.38	0.63	0.91	1.78	1.82	1.34	1.29	1.05	0.66	0.48	0.46	11.32
Kalispell, Mont.	30	1.47	1.15	1.11	1.22	2.04	2.30	1.41	1.25	1.20	0.96	1.45	1.65	17.21
Missoula, Mont.	30	1.06	0.77	0.96	1.09	1.95	1.73	1.09	1.15	1.08	0.83	0.96	1.15	13.82
Grand Island, Neb.	30	0.54	0.68	2.04	2.61	4.07	3.72	3.14	3.08	2.43	1.51	1.41	0.66	25.89
Lincoln, Neb.	30	0.67	0.66	2.21	2.90	4.23	3.51	3.54	3.35	2.92	1.94	1.58	0.86	28.37
Norfolk, Neb.	30	0.57	0.76	1.97	2.59	3.92	4.25	3.74	2.80	2.25	1.72	1.44	0.65	26.66
North Platte, Neb.	30	0.39	0.51	1.24	1.97	3.34	3.17	3.17	2.15	1.32	1.24	0.76	0.40	19.66

Normal Monthly Precipitation (Inches)

Normals 1971-2000	Yrs	Jan.	Feb.	Mar.	Apr.	May	June	July	Aug.	Sep.	Oct.	Nov.	Dec.	Ann.
Omaha Eppley Airport, Neb.	30	0.77	0.80	2.13	2.94	4.44	3.95	3.86	3.21	3.17	2.21	1.82	0.92	30.22
Omaha (North), Neb.	30	0.76	0.77	2.25	3.07	4.57	3.84	3.75	2.93	3.03	2.49	1.67	0.95	30.08
Scottsbluff, Neb.	30	0.54	0.58	1.16	1.79	2.70	2.65	2.13	1.19	1.22	1.01	0.80	0.56	16.33
Valentine, Neb.	30	0.30	0.48	1.11	1.97	3.20	3.01	3.37	2.20	1.61	1.22	0.72	0.33	19.52
Elko, Nev.	30	1.14	0.88	0.98	0.81	1.08	0.67	0.30	0.36	0.68	0.71	1.05	0.93	9.59
Ely, Nev.	30	0.74	0.75	1.05	0.90	1.29	0.66	0.60	0.91	0.94	1.00	0.63	0.50	9.97
Las Vegas, Nev.	30	0.59	0.69	0.59	0.15	0.24	0.08	0.44	0.45	0.31	0.24	0.31	0.40	4.49
Reno, Nev.	30	1.06	1.06	0.86	0.35	0.62	0.47	0.24	0.27	0.45	0.42	0.80	0.88	7.48
Winnemucca, Nev.	30	0.83	0.62	0.86	0.85	1.06	0.69	0.27	0.35	0.53	0.66	0.80	0.81	8.33
Concord, N.H.	30	2.97	2.36	3.04	3.07	3.33	3.10	3.37	3.21	3.16	3.46	3.57	2.96	37.60
Mt. Washington, N.H.	30	8.52	7.33	9.42	8.43	8.21	8.36	8.02	8.08	8.55	7.66	10.49	8.84	101.91
Atlantic City Airport, N.J.	30	3.60	2.85	4.06	3.45	3.38	2.66	3.86	4.32	3.14	2.86	3.26	3.15	40.59
Atlantic City C.O., N.J.	30	3.44	2.88	3.79	3.25	3.16	2.46	3.36	4.16	3.02	2.71	2.96	3.18	38.37
Newark, N.J.	30	3.98	2.96	4.21	3.92	4.46	3.40	4.68	4.02	4.01	3.16	3.88	3.57	46.25
Albuquerque, N.M.	30	0.49	0.44	0.61	0.50	0.60	0.65	1.27	1.73	1.07	1.00	0.62	0.49	9.47
Clayton, N.M.	30	0.30	0.27	0.62	0.99	2.08	2.21	2.81	2.69	1.56	0.74	0.54	0.32	15.13
Roswell, N.M.	30	0.39	0.41	0.35	0.58	1.30	1.62	1.99	2.31	1.98	1.29	0.53	0.59	13.34
Albany, N.Y.	30	2.71	2.27	3.17	3.25	3.67	3.74	3.50	3.68	3.31	3.23	3.31	2.76	38.60
Binghamton, N.Y.	30	2.58	2.46	2.97	3.49	3.55	3.80	3.49	3.35	3.59	3.02	3.32	3.03	38.65
Buffalo, N.Y.	30	3.16	2.42	2.99	3.04	3.35	3.82	3.14	3.87	3.84	3.19	3.92	3.80	40.54
Islip, N.Y.	30	4.27	3.33	4.76	4.13	3.90	3.71	2.93	4.48	3.39	3.63	3.86	4.13	46.52
New York C. Park, N.Y.	30	4.13	3.15	4.37	4.28	4.69	3.84	4.62	4.22	4.23	3.85	4.36	3.95	49.69
New York (JFK Airport), N.Y.	30	3.62	2.70	3.78	3.75	4.13	3.59	3.92	3.64	3.50	3.03	3.48	3.31	42.46
New York (LaGuardia Airport), N.Y.	30	3.56	2.75	3.93	3.68	4.16	3.57	4.41	4.09	3.77	3.26	3.67	3.51	44.36
Rochester, N.Y.	30	2.34	2.04	2.58	2.75	2.82	3.36	2.93	3.54	3.45	2.60	2.84	2.73	33.98
Syracuse, N.Y.	30	2.60	2.12	3.02	3.39	3.39	3.71	4.02	3.56	4.15	3.20	3.77	3.12	40.05
Asheville, N.C.	30	4.06	3.83	4.59	3.50	4.41	4.38	3.87	4.30	3.72	3.17	3.82	3.39	47.07
Cape Hatteras, N.C.	30	5.84	3.94	4.95	3.29	3.92	3.82	4.95	6.56	5.68	5.31	4.93	4.56	57.75
Charlotte, N.C.	30	4.00	3.55	4.39	2.95	3.66	3.42	3.79	3.72	3.83	3.66	3.36	3.18	43.51
Greensboro/Winston-Salem/High Point, N.C.	30	3.54	3.10	3.85	3.43	3.95	3.53	4.44	3.71	4.29	3.27	2.96	3.06	43.14

Normal Monthly Precipitation (Inches)

Normals 1971–2000	Yrs	Jan.	Feb.	Mar.	Apr.	May	June	July	Aug.	Sep.	Oct.	Nov.	Dec.	Ann.
Raleigh, N.C.	30	4.02	3.47	4.03	2.80	3.79	3.42	4.29	3.78	4.26	3.18	2.97	3.04	43.05
Wilmington, N.C.	30	4.52	3.66	4.22	2.94	4.40	5.36	7.62	7.31	6.79	3.21	3.26	3.78	57.07
Bismarck, N.D.	30	0.45	0.51	0.85	1.46	2.22	2.59	2.58	2.15	1.61	1.28	0.70	0.44	16.84
Fargo, N.D.	30	0.76	0.59	1.17	1.37	2.61	3.51	2.88	2.52	2.18	1.97	1.06	0.57	21.19
Grand Forks, N.D.	30	0.68	0.58	0.89	1.23	2.21	3.03	3.06	2.72	1.96	1.70	0.99	0.55	19.60
Williston, N.D.	30	0.54	0.39	0.74	1.05	1.88	2.36	2.28	1.48	1.35	0.87	0.65	0.57	14.16
Akron, Ohio	30	2.49	2.28	3.15	3.39	3.96	3.55	4.02	3.65	3.43	2.53	3.04	2.98	38.47
Cleveland, Ohio	30	2.48	2.29	2.94	3.37	3.50	3.89	3.52	3.69	3.77	2.73	3.38	3.14	38.71
Columbus, Ohio	30	2.53	2.20	2.89	3.25	3.88	4.07	4.61	3.72	2.92	2.31	3.19	2.93	38.52
Dayton, Ohio	30	2.60	2.29	3.29	4.03	4.17	4.21	3.75	3.49	2.65	2.72	3.30	3.08	39.58
Mansfield, Ohio	30	2.63	2.17	3.36	4.17	4.42	4.52	4.22	4.60	3.44	2.68	3.76	3.26	43.24
Toledo, Ohio	30	1.93	1.88	2.62	3.24	3.14	3.80	2.80	3.19	2.84	2.35	2.78	2.64	33.21
Youngstown, Ohio	30	2.34	2.03	3.05	3.33	3.45	3.91	4.10	3.43	3.89	2.46	3.07	2.96	38.02
Oklahoma City, Okla.	30	1.28	1.56	2.90	3.00	5.44	4.63	2.94	2.48	3.98	3.64	2.11	1.89	35.85
Tulsa, Okla.	30	1.60	1.95	3.57	3.95	6.11	4.72	2.96	2.85	4.76	4.05	3.47	2.43	42.42
Astoria, Ore.	30	9.62	7.87	7.37	4.93	3.28	2.57	1.16	1.21	2.61	5.61	10.50	10.40	67.13
Burns, Ore.	30	1.18	1.11	1.24	0.85	1.05	0.66	0.40	0.45	0.50	0.72	1.11	1.30	10.57
Eugene, Ore.	30	7.65	6.35	5.80	3.66	2.66	1.53	0.64	0.99	1.54	3.35	8.44	8.29	50.90
Medford, Ore.	30	2.47	2.10	1.85	1.31	1.21	0.68	0.31	0.52	0.78	1.31	2.93	2.90	18.37
Pendleton, Ore.	30	1.45	1.22	1.26	1.13	1.22	0.78	0.41	0.56	0.63	0.99	1.63	1.48	12.76
Portland, Ore.	30	5.07	4.18	3.71	2.64	2.38	1.59	0.72	0.93	1.65	2.88	5.61	5.71	37.07
Salem, Ore.	30	5.84	5.09	4.17	2.76	2.13	1.45	0.57	0.68	1.43	3.03	6.39	6.46	40.00
Sexton Summit, Ore.	30	4.71	4.29	3.92	2.38	1.35	0.94	0.35	0.61	1.20	2.93	5.32	5.18	33.18
Guam	30	5.58	5.11	4.24	4.16	6.39	6.28	11.66	16.17	13.69	11.88	9.34	6.11	100.61
Johnston Island	30	1.64	1.29	2.01	1.86	1.14	0.87	1.40	2.07	2.46	2.78	4.78	2.70	25.00
Koror, Caroline Islands	30	11.20	9.65	8.79	9.45	11.27	17.54	16.99	14.47	11.65	13.41	11.62	12.33	148.37
Kwajalein, Marshall Islands	30	5.12	3.73	3.82	7.63	8.62	8.86	10.24	10.42	11.82	11.46	10.74	7.94	100.40
Majuro, Marshall Islands	30	8.09	6.86	8.43	11.30	11.53	11.09	12.41	11.95	11.96	13.73	12.81	11.50	131.66
Pago Pago, Amer. Samoa	30	14.02	12.14	11.15	11.16	10.43	5.94	5.76	6.43	7.36	10.03	11.16	13.38	118.96
Pohnpei, Caroline Islands	30	12.52	9.78	13.96	16.94	19.41	17.06	16.72	16.37	14.94	16.30	14.74	15.87	184.61

Normal Monthly Precipitation (Inches)

Normals 1971–2000	Yrs	Jan.	Feb.	Mar.	Apr.	May	June	July	Aug.	Sep.	Oct.	Nov.	Dec.	Ann.
Chuuk, E. Caroline Islands	30	8.58	8.77	8.15	10.94	11.29	12.82	12.45	15.09	13.12	10.69	11.09	10.98	133.97
Wake Island	30	1.40	1.89	2.38	2.11	1.70	1.95	3.44	5.62	4.82	4.27	2.78	1.87	34.23
Yap, W. Caroline Islands	30	7.24	5.45	6.14	5.58	8.15	13.46	13.25	14.41	13.53	12.25	8.82	9.34	117.62
Allentown, Pa.	30	3.50	2.75	3.56	3.49	4.47	3.99	4.27	4.35	4.37	3.33	3.70	3.39	45.17
Erie, Pa.	30	2.53	2.28	3.13	3.38	3.34	4.28	3.28	4.21	4.73	3.92	3.96	3.73	42.77
Harrisburg, Pa.	30	3.18	2.88	3.58	3.31	4.60	3.99	3.21	3.24	3.65	3.06	3.53	3.22	41.45
Middletown/Harrisburg Intl Airport, Pa.	30	3.18	2.88	3.58	3.31	4.60	3.99	3.21	3.24	3.65	3.06	3.53	3.22	41.45
Philadelphia, Pa.	30	3.52	2.74	3.81	3.49	3.88	3.29	4.39	3.82	3.88	2.75	3.16	3.31	42.05
Pittsburgh, Pa.	30	2.70	2.37	3.17	3.01	3.80	4.12	3.96	3.38	3.21	2.25	3.02	2.86	37.85
Avoca, Pa.	30	2.46	2.08	2.69	3.28	3.69	3.97	3.74	3.10	3.86	3.02	3.12	2.55	37.56
Williamsport, Pa.	30	2.85	2.61	3.21	3.49	3.79	4.45	4.08	3.38	3.98	3.19	3.62	2.94	41.59
Block Is., R.I.	30	3.68	3.04	3.99	3.72	3.40	2.77	2.62	3.00	3.19	3.04	3.77	3.57	39.79
Providence, R.I.	30	4.37	3.45	4.43	4.16	3.66	3.38	3.17	3.90	3.70	3.69	4.40	4.14	46.45
Charleston Airport, S.C.	30	4.08	3.08	4.00	2.77	3.67	5.92	6.13	6.91	5.98	3.09	2.66	3.24	51.53
Charleston C.O., S.C.	30	3.62	2.62	3.83	2.44	2.77	4.96	5.50	6.54	6.13	3.02	2.18	2.78	46.39
Columbia, S.C.	30	4.66	3.84	4.59	2.98	3.17	4.99	5.54	5.41	3.94	2.89	2.88	3.38	48.27
Greenville-Spartanburg Airport, S.C.	30	4.41	4.24	5.31	3.53	4.59	3.92	4.65	4.08	3.96	3.88	3.79	3.86	50.24
Aberdeen, S.D.	30	0.48	0.48	1.34	1.83	2.69	3.49	2.92	2.42	1.81	1.63	0.75	0.38	20.22
Huron, S.D.	30	0.48	0.57	1.67	2.29	3.00	3.28	2.86	2.07	1.80	1.59	0.89	0.39	20.90
Rapid City, S.D.	30	0.37	0.46	1.03	1.86	2.96	2.83	2.03	1.61	1.10	1.37	0.61	0.40	16.64
Sioux Falls, S.D.	30	0.51	0.51	1.81	2.65	3.39	3.49	2.93	3.01	2.58	1.93	1.36	0.52	24.69
Bristol-Johnson City-Kingsport, Tenn.	30	3.52	3.40	3.91	3.23	4.32	3.89	4.21	3.00	3.08	2.30	3.08	3.39	41.33
Chattanooga, Tenn.	30	5.40	4.85	6.19	4.23	4.28	3.99	4.73	3.59	4.31	3.26	4.88	4.81	54.52
Knoxville, Tenn.	30	4.57	4.01	5.17	3.99	4.68	4.04	4.71	2.89	3.04	2.65	3.98	4.49	48.22
Memphis, Tenn.	30	4.24	4.31	5.58	5.79	5.15	4.30	4.22	3.00	3.31	3.31	5.76	5.68	54.65
Nashville, Tenn.	30	3.97	3.69	4.87	3.93	5.07	4.08	3.77	3.28	3.59	2.87	4.45	4.54	48.11
Oak Ridge, Tenn.	30	5.13	4.50	5.72	4.32	5.14	4.64	5.16	3.39	3.75	3.02	4.86	5.42	55.05
Abilene, Texas	30	0.97	1.13	1.41	1.67	2.83	3.06	1.69	2.63	2.91	2.90	1.30	1.27	23.78
Amarillo, Texas	30	0.63	0.55	1.13	1.33	2.50	3.28	2.68	2.94	1.88	1.50	0.68	0.61	19.71
Austin, Texas	30	1.89	1.99	2.14	2.51	5.03	3.81	1.97	2.31	2.91	3.97	2.68	2.44	33.65

Normal Monthly Precipitation (Inches)

Normals 1971–2000	Yrs	Jan.	Feb.	Mar.	Apr.	May	June	July	Aug.	Sep.	Oct.	Nov.	Dec.	Ann.
Austin/Bergstrom, Texas	30	2.20	1.73	1.98	2.77	5.87	3.38	1.61	1.48	2.63	2.70	2.61	2.39	31.36
Brownsville, Texas	30	1.36	1.18	0.93	1.96	2.48	2.93	1.77	2.99	5.31	3.78	1.75	1.11	27.55
Corpus Christi, Texas	30	1.62	1.84	1.73	2.05	3.48	3.53	2.00	3.54	5.03	3.94	1.74	1.75	32.26
Dallas-Fort Worth, Texas	30	1.90	2.37	3.06	3.20	5.15	3.23	2.12	2.03	2.42	4.11	2.57	2.57	34.73
Dallas-Love Field, Texas	30	1.89	2.31	3.13	3.46	5.30	3.92	2.43	2.17	2.65	4.65	2.61	2.53	37.05
Del Rio, Texas	30	0.57	0.96	0.96	1.71	2.31	2.34	2.02	1.59	2.06	2.00	0.96	0.75	18.23
El Paso, Texas	30	0.45	0.39	0.26	0.23	0.38	0.87	1.49	1.75	1.61	0.81	0.42	0.77	9.43
Galveston, Texas	30	4.08	2.61	2.76	2.56	3.70	4.04	3.45	4.22	5.76	3.49	3.64	3.53	43.84
Houston, Texas	30	3.68	2.98	3.36	3.60	5.15	5.35	3.18	3.83	4.33	4.50	4.19	3.69	47.84
Lubbock, Texas	30	0.50	0.71	0.76	1.29	2.31	2.98	2.13	2.35	2.57	1.70	0.71	0.67	18.69
Midland-Odessa, Texas	30	0.53	0.58	0.42	0.73	1.79	1.71	1.89	1.77	2.31	1.77	0.65	0.65	14.80
Port Arthur, Texas	30	5.69	3.35	3.75	3.84	5.83	6.58	5.23	4.85	6.10	4.67	4.75	5.25	59.89
San Angelo, Texas	30	0.81	1.18	0.99	1.60	3.09	2.52	1.10	2.05	2.95	2.57	1.10	0.94	20.91
San Antonio, Texas	30	1.66	1.75	1.89	2.60	4.72	4.30	2.03	2.57	3.00	3.86	2.58	1.96	32.92
Victoria, Texas	30	2.44	2.04	2.25	2.97	5.12	4.96	2.90	3.05	5.00	4.26	2.64	2.47	40.10
Waco, Texas	30	1.90	2.43	2.48	2.99	4.46	3.08	2.23	1.85	2.88	3.67	2.61	2.76	33.34
Wichita Falls, Texas	30	1.12	1.57	2.27	2.62	3.92	3.69	1.58	2.38	3.19	3.11	1.68	1.68	28.83
Milford, Utah	30	0.73	0.77	1.21	0.99	0.94	0.44	0.76	1.04	0.92	1.12	0.77	0.58	10.27
Salt Lake City, Utah	30	1.37	1.33	1.91	2.02	2.09	0.77	0.72	0.76	1.33	1.57	1.40	1.23	16.50
Burlington, Vt.	30	2.22	1.67	2.32	2.88	3.32	3.43	3.97	4.01	3.83	3.12	3.06	2.22	36.05
Lynchburg, Va.	30	3.54	3.10	3.83	3.46	4.11	3.79	4.39	3.41	3.88	3.39	3.18	3.23	43.31
Norfolk, Va.	30	3.93	3.34	4.08	3.38	3.74	3.77	5.17	4.79	4.06	3.47	2.98	3.03	45.74
Richmond, Va.	30	3.55	2.98	4.09	3.18	3.95	3.54	4.67	4.18	3.98	3.60	3.06	3.12	43.91
Roanoke, Va.	30	3.23	3.08	3.84	3.61	4.24	3.68	4.00	3.74	3.85	3.15	3.21	2.86	42.49
Olympia, Wash.	30	7.54	6.17	5.29	3.58	2.27	1.78	0.82	1.10	2.03	4.19	8.13	7.89	50.79
Quillayute, Wash.	30	13.65	12.35	10.98	7.44	5.51	3.50	2.34	2.67	4.15	9.81	14.82	14.50	101.72
Seattle C.O., Wash.	30	5.24	4.09	3.92	2.75	2.03	1.55	0.93	1.16	1.61	3.24	5.67	6.06	38.25
Seattle Sea-Tac Ap, Wash.	30	5.13	4.18	3.75	2.59	1.77	1.49	0.79	1.02	1.63	3.19	5.90	5.62	37.07
Spokane, Wash.	30	1.82	1.51	1.53	1.28	1.60	1.18	0.76	0.68	0.76	1.06	2.24	2.25	16.67
Walla Walla, Wash.	30	2.25	1.97	2.20	1.83	1.95	1.15	0.73	0.84	0.83	1.77	2.85	2.51	20.88

Normal Monthly Precipitation (Inches)

Normals 1971–2000	Yrs	Jan.	Feb.	Mar.	Apr.	May	June	July	Aug.	Sep.	Oct.	Nov.	Dec.	Ann.
Yakima, Wash.	30	1.17	0.80	0.70	0.53	0.51	0.62	0.22	0.36	0.39	0.53	1.05	1.38	8.26
San Juan, P.R.	30	3.02	2.30	2.14	3.71	5.29	3.52	4.16	5.22	5.60	5.06	6.17	4.57	50.76
Beckley, W.Va.	30	3.23	2.96	3.63	3.42	4.39	3.92	4.78	3.45	3.23	2.64	2.88	3.09	41.63
Charleston, W.Va.	30	3.25	3.19	3.90	3.25	4.30	4.09	4.86	4.11	3.45	2.67	3.66	3.32	44.05
Elkins, W.Va.	30	3.43	3.20	3.92	3.53	4.77	4.61	4.83	4.26	3.82	2.86	3.42	3.44	46.11
Huntington, W.Va.	30	3.21	3.09	3.83	3.33	4.41	3.88	4.46	3.88	2.80	2.73	3.32	3.37	42.31
Green Bay, Wis.	30	1.21	1.01	2.06	2.56	2.75	3.43	3.44	3.77	3.11	2.17	2.27	1.41	29.19
LaCrosse, Wis.	30	1.19	0.99	2.00	3.38	3.38	4.00	4.25	4.28	3.40	2.16	2.10	1.23	32.36
Madison, Wis.	30	1.25	1.28	2.28	3.35	3.25	4.05	3.93	4.33	3.08	2.18	2.31	1.66	32.95
Milwaukee, Wis.	30	1.85	1.65	2.59	3.78	3.06	3.56	3.58	4.03	3.30	2.49	2.70	2.22	34.81
Casper, Wyo.	30	0.58	0.64	0.90	1.52	2.38	1.43	1.29	0.73	0.98	1.14	0.82	0.62	13.03
Cheyenne, Wyo.	30	0.45	0.44	1.05	1.55	2.48	2.12	2.26	1.82	1.43	0.75	0.64	0.46	15.45
Lander, Wyo.	30	0.52	0.54	1.24	2.07	2.38	1.15	0.84	0.57	1.14	1.37	0.99	0.61	13.42
Sheridan, Wyo.	30	0.77	0.57	1.00	1.77	2.41	2.02	1.11	0.80	1.38	1.41	0.80	0.68	14.72

BLANK PAGE

APPENDIX C
SPCC TYPICAL EXAMPLE

Typical Example: The following SPCC plan was created as an illustration for instructional purposes. The oil retention method and cleanup procedures used in this plan should not be construed as the best or only methods available but are intended to illustrate the engineering decisions that must be made for each electrical facility.

BLANK PAGE

**OIL SPILL PREVENTION, CONTROL, AND
COUNTERMEASURES PLAN
FOR
(NAME OF SUBSTATION OR FACILITY)**

Prepared by:
(PREPARER)
(TITLE)
for
(NAME OF COOPERATIVE)
(ADDRESS)
(CITY, STATE, ZIP CODE)
TEL: (xxx) xxx-xxxx
FAX: (xxx) xxx-xxxx

OIL SPILL PREVENTION CONTROL AND COUNTERMEASURES PLAN

TABLE OF CONTENTS

Required Plan Elements Listed in 40 CFR Part 112	C-4
A. NAME AND TYPE OF FACILITY	C-5
B. LOCATION OF FACILITY	C-5
C. DATE OF INITIAL OPERATION	C-6
D. IDENTIFICATION OF INDIVIDUAL RESPONSIBLE FOR OIL SPILL PREVENTION	C-6
E. MANAGEMENT APPROVAL	C-6
F. P.E. CERTIFICATION	C-7
G. RECORD OF PLAN REVIEWS	C-7
H. RECORD OF AMENDMENTS AND REVISIONS TO SPCC PLAN	C-8
I. OIL SPILL HISTORY	C-8
J. FACILITY'S CONFORMANCE PLAN AND ANALYSIS	C-8
K. REPORTING AND NOTIFICATION	C-9
L. GOVERNMENT AGENCIES TO BE NOTIFIED	C-9
M. SPILL RESPONSE CONTRACTOR INFORMATION	C-10
Forms: Notification Form	C-11
Description of Spill Event Form	C-12

OIL SPILL PREVENTION CONTROL AND COUNTERMEASURES PLAN

Prelude—Required Plan Elements Listed in 40 CFR Part 112

A. Name and Type of Facility

Facility Name: _____
 Facility Type: _____
 Address: _____
 Phone at site: _____
 Phone at nearest manned station: _____ Location: _____
 Total oil volume contained on-site: _____
 Volume in largest single container or piece of equipment: _____

Drawing of Facility Attached: Drawing No. _____ Date _____

Oil Containing Equipment (55 gallons or more)	Type of Oil	Volume (gallons)	PCB Content (ppm) if present
_____	_____	_____	_____
_____	_____	_____	_____
_____	_____	_____	_____
_____	_____	_____	_____
_____	_____	_____	_____

This facility is normally unmanned but is visited on a regular basis—at least once a month. The facility is fenced and locked during unattended hours. Facility lighting is adequate and ___ is or ___ is not on all night. Past spills ___ have or ___ have not occurred at this facility. If spills have occurred, additional information on past spills is provided in the Appendix of this plan.

B. Location of Facility

The facility is located in _____, _____ in _____ County,
 in the _____ quarter of the _____ quarter of Section _____, in Township _____
 Range _____.

C. Date of Initial Operation

This facility began operation on _____.

D. Identification of Responsible Individual for Oil Spill Prevention

The responsible individual for this facility is:

Name: _____

Title: _____

Phone: _____

E. Management Approval

This SPCC Plan has been reviewed by me and will be implemented as herein described. Company resources, including manpower, equipment, and materials necessary to contain, control, and remove any harmful quantities of oil spilled will be obtained.

Name: _____

Title: _____

Signature

Date Signed: _____

F. P.E. Certification

I hereby certify that I or my agent have visited and examined the facility known herein as _____ and that I am familiar with the provisions of 40 CFR Part 112—Oil Pollution Prevention. I attest that this SPCC Plan (1) has been prepared in accordance with good engineering practices, including consideration of applicable industry standards; (2) is adequate for this facility; and (3) that procedures for required testing and inspections have been established.

Printed Name of Registered Professional Engineer

Signature of Registered Professional Engineer

Date Signed _____ Registration No. _____ State _____

G. Record of Plan Reviews

(Required at least once every five years or when there has been a significant change to the facility.)

I have completed review and evaluation of this SPCC Plan on the following date:

<u>Date</u>	<u>Result of Review</u>
_____, and I _____ will _____ will not amend the plan as a result.	_____ (signature of reviewer)
_____, and I _____ will _____ will not amend the plan as a result.	_____ (signature of reviewer)
_____, and I _____ will _____ will not amend the plan as a result.	_____ (signature of reviewer)

_____, and I _____ will _____ will not amend the plan as a result.

_____ (signature of reviewer)

_____, and I _____ will _____ will not amend the plan as a result.

_____ (signature of reviewer)

_____, and I _____ will _____ will not amend the plan as a result.

_____ (signature of reviewer)

H. Record of Amendments and Revisions to SPCC Plan

<u>Date</u>	<u>Page(s)</u>	<u>Subject/Reason</u>	<u>Initials</u>
-------------	----------------	-----------------------	-----------------

I. Oil Spill History

Since the construction of this substation in _____, there have been _____ oil spill incident(s). Details of these spills, if any, are included in the Appendix to this SPCC Plan.

J. Facility's Conformance Plan and Analysis

In the event of an oil spill at this facility under normal weather conditions, the maximum potential spill of _____ gallons of oil (from the single largest piece of oil-filled equipment) would be contained within the station's gravel bed and/or immediate vicinity. During periods of heavy rainfall, oil and water would flow _____

Four to six inches of rock gravel surfacing are normally required in all electrical facility yards. This design feature benefits the operation and maintenance of the facility by providing proper site drainage, reducing step and touch potentials during short circuit faults, eliminating weed growth, improving yard working conditions, and enhancing station aesthetics. In addition to these advantages, this gravel bed will aid in fire control

and in reducing potential oil spill cleanup costs and penalties that may arise from Federal and State environmental laws and regulations.

The yard surfacing at this substation serves as the secondary method of containment. It limits the flow of oil in the event the primary method—the tank—fails. It is unlikely that a spill would migrate beyond the yard surfacing. As shown on the grading plan, the surfaced area surrounds the largest piece of oil-filled equipment by a radius of at least _____ feet.

Within this radius, the substation itself has been graded to be essentially flat, allowing only enough grade for surface water runoff. Although the yard surfacing and grading allow easy runoff of water (low viscosity), they act to check the flow and spread of oil (high viscosity). See Section II.C.

Any equipment necessary for cleanup is kept at _____—a permanently manned facility located at _____, approximately _____ road miles from this facility. The personnel at _____ located in _____ would be responsible for the cleanup. The _____ station is located at _____. Phone number: _____.

While the _____ station is the primary location of cleanup equipment, oil spill cleanup equipment also is located at (1) _____; (2) _____; and (3) _____.

K. Reporting and Notification

The Spill Response Coordinator for this site is:

Name: _____
 Work Phone: _____
 Home Phone: _____
 Cell Phone: _____

Alternate coordinators are:

Name: _____
 Work Phone: _____
 Home Phone: _____
 Cell Phone: _____

Name: _____
 Work Phone: _____
 Home Phone: _____
 Cell Phone: _____

L. Government Agencies to be Notified

If an oil release to water is imminent or has occurred, the coordinator will notify (the designated utility department person or persons—use title). He/she or a representative of this department will notify the appropriate local, State, and Federal agencies. If representatives of the above department cannot be reached, notification to outside agencies will be made by the coordinator.

The following agencies should be contacted if a spill has reached surface water:

County Office of Emergency Services: _____

State Department of Environmental Quality: _____

National Response Center (U.S. Coast Guard): Phone:

Downstream Water Suppliers:

City: Company: Phone:

City: Company: Phone:

Information on the spill—see Notification Form at the end of this section—should be at hand when these calls are made.

M. Spill Response Contractor Information

Spill Response Contractor: Spill Responders, Inc.

Phone:

Notification Form

Items 1–6 should be completed before contacting government agencies. The agencies need this information at a minimum to access the seriousness of the spill.

Date: _____

1. Name of Company _____

2. Date of Spill _____

3. Time of Spill _____ (est. ___ known ___) Time Spill Detected _____ (est. ___ known ___)

4. Location of Spill _____

5. Name of Receiving Body of Water _____

6. Material and Amount Spilled _____ Gallons of _____

7. Probable Source or Cause _____

8. Actions Initiated to Contain or Cleanup _____

9. Person to Contact on Scene

Name _____ Phone _____

10. Report Initiated by

Name _____

Title _____

Phone _____

11. Government Agency Official(s) Notified

Name _____ Date _____ Time _____

Title _____

Phone _____

Description of Spill Event Form

Date: _____

1. *Facility name and location _____

2. *Date when facility began operation _____

3. *Owner and operator at time of spill _____

4. *Name and address of registered agent of owner or operator _____

5. *Maximum storage or handling facility at time of spill _____

6. *Normal daily throughput _____

7. *Type of oil or fluid that spilled _____ *Volume released _____

8. *Likely cause of release _____

9. *Equipment involved _____

10. *Corrective actions and/or countermeasures taken to stop or mitigate discharge _____

11. *Any changes in equipment or procedures made to prevent similar spills in the future: _____

12. Date of spill _____ Was it raining at time of spill? _____
13. Was water or foam used for fire suppression at time of spill? _____
14. Estimated quantity reaching waterbody _____ Name of waterbody _____
15. Cleanup measures used on-site _____
16. Volume of soil removed _____ Volume of oil removed _____
17. Cleanup measures used for waterbody _____
18. Observed environmental effects, if any, after cleanup _____
-
-

*Required information under Sec. 112.4 if one spill event of 1,000 gallons or greater of oil occurs or two spills within a consecutive 12-month period occur. Other information could be used by utility to improve spill prevention and control procedures. If a spill meeting the above criteria occurs, required information and copy of SPCC Plan must be submitted to EPA Regional Administrator within 60 days of applicable spill and a copy sent to the _____ Department of Environmental Quality.

BLANK PAGE

APPENDIX D OPTIONAL SPCC WALL PLAN

Spill Prevention, Control and Countermeasure Plan Giddings Substation

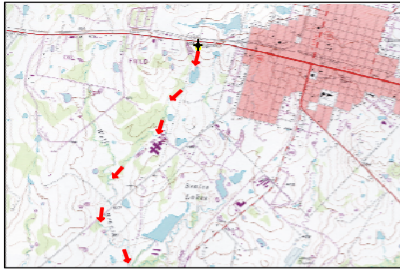

Figure 1. Giddings Substation & Spill Flow Direction

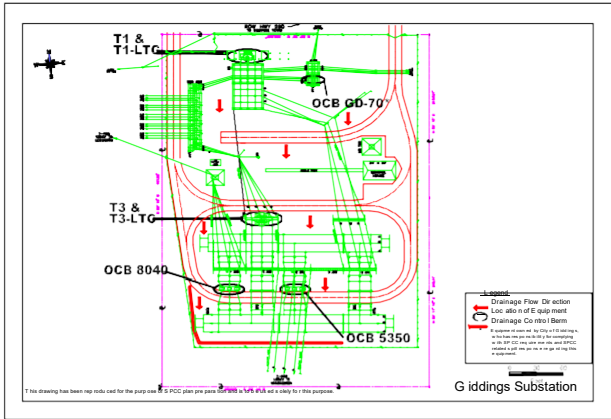

Figure 2. Giddings Substation Layout

1.0 SITE INFORMATION

1.1 Location and Directions

This spill prevention, control and countermeasure (SPCC) Plan provides the following information to be used in responding to oil spills at the LCRRA Giddings Substation. The facility is located in LCRRA on Highway 177. The facility is currently used as a substation and there are no plans to change its current use in the near future.

This plan adds to the LCRRA site and equipment. The owner or user of this plan is advised to conduct an SPCC risk assessment to determine if it is a spill of an oil that is subject to SPCC regulations and to determine if it is a spill of an oil that is subject to SPCC regulations and to determine if it is a spill of an oil that is subject to SPCC regulations.

Directions to the facility: From the intersection of Highway 177 and Highway 177 in Giddings, go approximately 0.8 miles west, on the left.

911 Address: 1398 W. Ansite St., Giddings, TX 78642

Facility phone number: (979) 542-2351

1.2 Spill Path Prediction

Determine the spill path from the substation. The spill path is determined by the spill location and the spill path. The spill path is determined by the spill location and the spill path. The spill path is determined by the spill location and the spill path.

2.0 SPILL CONTACTS

Name/Department	Address	Phone	Notes
Local Fire Department	1412 S. 4th Street	(409) 233-1199	Fire Department
Local Police Department	1121 S. 1st Street	(409) 233-1111	Police Department
Environmental Services Inc.	1412 S. 4th Street	(409) 233-1199	Environmental Services Inc.
Waste Coordinator	1412 S. 4th Street	(409) 233-1199	Waste Coordinator
Oil Spill Response Contractor	1412 S. 4th Street	(409) 233-1199	Oil Spill Response Contractor
Safety Department	1412 S. 4th Street	(409) 233-1199	Safety Department
Oil Spill Response Team	1412 S. 4th Street	(409) 233-1199	Oil Spill Response Team
Oil Spill Response Team	1412 S. 4th Street	(409) 233-1199	Oil Spill Response Team

3.0 AGENCY & OTHER CONTACTS

Emergency Response Contact:

- Local Fire Department: (979) 542-2351
- Local Police Department: (979) 542-2351
- Environmental Services Inc.: (979) 542-2351
- Oil Spill Response Contractor: (979) 542-2351
- Safety Department: (979) 542-2351

HAZMAT Contractor: HAZMAT Contractor - 24-hour spill response. The contractor will be contacted in the event of an oil spill. The contractor will be contacted in the event of an oil spill. The contractor will be contacted in the event of an oil spill.

Oil Spill Response Team: Oil Spill Response Team - 24-hour spill response. The team will be contacted in the event of an oil spill. The team will be contacted in the event of an oil spill. The team will be contacted in the event of an oil spill.

4.0 SPILL REPORTING REQUIREMENTS

Spill Type	Reporting Agency	Reporting Method
PCBs	EPA	10 pounds
Oil	EPA / NRC / TCEQ	Any amount
Other	TCEQ	20 gallons

TABLE 1 EQUIPMENT INFORMATION

ID	Type of Equipment	Oil - gallons	Drainage Controls	Countermeasures
T3	Transformer	4,800	IGL, ODC	SR
T1	Transformer	4,200	IGL, ODC	SR
OCB 5350	Oil Circuit Breaker	2,151	IGL, ODC	SR
OCB 8040	Oil Circuit Breaker	2,151	IGL, ODC	SR
T1-LTC	Lead Tap Changer	100	IGL, ODC	SR
T3-LTC	Lead Tap Changer	100	IGL, ODC	SR
OCB GD-70	Oil Circuit Breaker	74	IGL, ODC	SR

Oil Incessant Oil
Drainage Controls: IGL = Insulating Gland Layer, ODC = Secondary Containment (near), SR = Restraint Structure (ump, impoundment), ODC = Oil Spill Drainage Controls (form, elevated, etc.)
Countermeasures: SR = Spill Response: LCRRA has a 24-hour spill response program.
Equipment owned by City of Giddings. City of Giddings has responsibility for complying with SPCC requirements and SPCC-related spill response.

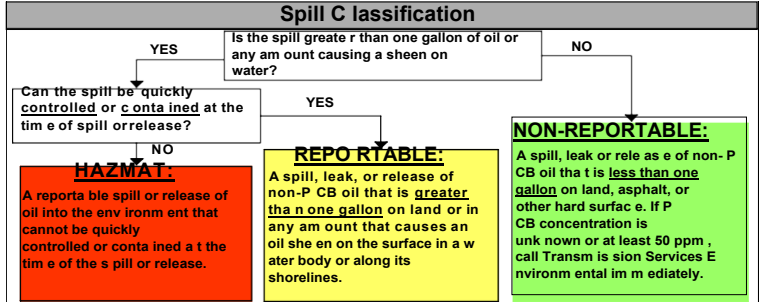

Emergency Spill Response Procedures

HAZMAT	REPORTABLE	NO-REPORTABLE
Notify: 1. 911 (if there is fire or injuries) 2. SOCC (512-482-6220) 3. TOCC (512-369-8911) 4. Supervisor	Notify: 1. Supervisor 2. Transmision Services Environmental (See Section 2.0 for list of phone numbers) 3. TOCC (512-369-8911)	Notify: Transmision Services Environmental if spill is on soil (See Section 2.0 for list of phone numbers)
Report: 1. Your name and call back number 2. The exact location and nature of the incident 3. The number of personnel affected and any pertinent information	Report: 1. Your name and call back number 2. The exact location and nature of the incident 3. The number of personnel affected and any pertinent information	Report: Not necessary for non-reportable spills
Priority Actions: 1. Designate the On site Commander (highest ranking person on site). 2. Assess all hazards, particularly electrical hazards, fires, and hazardous materials (including PCBs) releases by fire or discharge to oil or water. 3. Enter the area wearing PPE only when safety hazards have been controlled and stop the spill if it can be done safely. Otherwise, wait for Hazmat Contractor to arrive. 4. Barricade the area (use yellow warning tape) and limit access to authorized personnel wearing appropriate PPE. 5. Remain at scene until relieved.	Priority Actions: 1. Assess all hazards, particularly electrical hazards, fires, and hazardous materials (including PCBs) releases by fire or discharge to soil or water. 2. Enter the area wearing PPE only when safety hazards have been controlled and stop the spill if it can be done safely. 3. Barricade the area (use yellow warning tape) and limit access to authorized personnel wearing appropriate PPE.	Priority Actions: Cover the affected area with sorbents or an approved bio-restoration solution.
Removal of Contaminated Media: Transmision Services Environmental will collect samples and arrange disposal at an authorized disposal facility.	Removal of Contaminated Media: 1. Clean up all visible traces of contamination on hard surfaces. Excavate contaminated soil and collect contaminated water. 2. Place the contaminated media in containers or in a controlled staging area. 3. Transmision Services Environmental will collect samples and arrange disposal at an authorized disposal facility.	Removal of Contaminated Media: 1. Clean up all visible traces of contamination on hard surfaces. Excavate contaminated soil, if necessary. 2. Place the contaminated media in designated containers. 3. Contact Waste Coordinator for waste management instructions (512-356-0039).
Follow up: Transmision Services Environmental will complete Telephone Spill Report and contact appropriate regulatory agencies.	Follow up: Transmision Services Environmental will complete Telephone Spill Report and contact appropriate regulatory agencies, if necessary.	Follow up: Not necessary for non-reportable spills.

5.0 PROFESSIONAL ENGINEER'S CERTIFICATION

This SPCC Plan has been prepared by a duly-licensed professional engineer. The maintenance of this SPCC Plan by a registered professional engineer is required by 49 CFR 11.12 (d) in order to be eligible for the LCRRA Transmision Services Environmental program. The LCRRA Transmision Services Environmental program is a spill response program that provides 24-hour spill response services to LCRRA Transmision Services Environmental customers.

6.0 WRITTEN COMPLETION OF MANPOWER, EQUIPMENT, AND MATERIALS

This SPCC Plan has been prepared by a duly-licensed professional engineer. The maintenance of this SPCC Plan by a registered professional engineer is required by 49 CFR 11.12 (d) in order to be eligible for the LCRRA Transmision Services Environmental program. The LCRRA Transmision Services Environmental program is a spill response program that provides 24-hour spill response services to LCRRA Transmision Services Environmental customers.

Approved by: E. PALM, Environmental Protection Agency, Region 6, NRC, National Response Center, TX-025
Approved by: E. PALM, Environmental Protection Agency, Region 6, NRC, National Response Center, TX-025
Approved by: E. PALM, Environmental Protection Agency, Region 6, NRC, National Response Center, TX-025
Approved by: E. PALM, Environmental Protection Agency, Region 6, NRC, National Response Center, TX-025

BLANK PAGE

APPENDIX E

CONTRIBUTORS

The following members of the National Rural Electric Cooperative Association (NRECA) Transmission & Distribution (T&D) Substation Subcommittee provided invaluable assistance in preparing this document.

Dan Geiger, **Heartland Engineering Services**, Rockford, MN
Bil Kahanek, **Lower Colorado River Authority**, Austin, TX
Ken Malone, **Middle Tennessee EMC**, Murfreesboro, TN
Allen Xi, **Burns & McDonnell**, Houston, TX
Paul Rupard, **East Kentucky Power Cooperative**, Winchester, KY
Thomas Barnette, **Berkeley Electric Cooperative**, Moncks Corner, SC
Tom Myers, **Berkeley Electric Cooperative**, Moncks Corner, SC
Mike Eskandary, **Rural Development, Utilities Programs**, Washington, D.C.
Norris Nicholson, **Rural Development, Utilities Programs**, Washington, D.C.
Mike Pehosh, **NRECA**, Arlington, VA
James Stine, **NRECA**, Arlington, VA
Bob Saint, **NRECA**, Arlington, VA
Kevin White, **Northeast Missouri Electric Power**, Palmyra, Missouri
Mike Avant, **Garkane Energy Cooperative**, Loa, UT
Kenny Adams, **SGS Witter Inc.**, Albuquerque, NM
Jim Bardwell, **SGS Witter Inc.**, Albuquerque, NM
Shawn Higbe, **McCall-Thomas Engineering, Inc.**, Orangeburg, SC
Kevin Seesholtz, **South Central Power Co.** Canal Winchester, OH
Mike Garland, Jr., **Mountain View Electric Assn.**, Limon, CO
Kevin Groves, **West Plains Engineering Inc.**, West Plains, MO
Jared Newton, **United Services Group**, Elk River, MN
Kirk Powell, **Burns & McDonnell**, Houston, TX